

2014

**Optimisation of a LP steam turbine stage & diffuser
in FINE™/Design3D**

Dr. Thomas Hildebrandt, Jana Vachova, Sven Albert



1

**FINE™/Design3D:
Neural Network & Genetic Algorithm**

2

Case: LP Steam Turbine & Exhaust Casing

3

Results: Database

4

Results: Optimisation



1

**FINE™/Design3D:
Neural Network & Genetic Algorithm**



Challenges in Turbomachinery Optimisation:

- Multiple & contradictory targets, e.g. increased efficiency, pressure ratio, surge margin...
- Secondary targets & constraints, e.g. blade thickness & strength, fabrication
- Complex geometries, hence large number of free parameters



N-dimensional objective function
& lots of local extrema

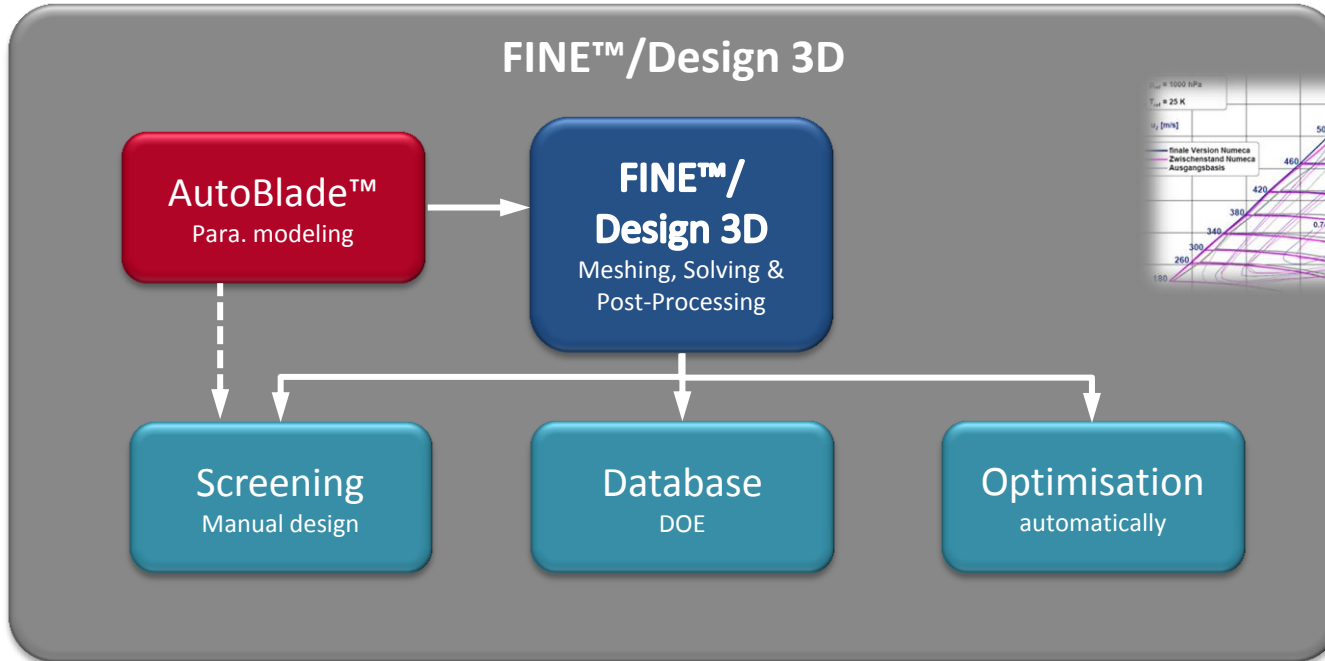

Original

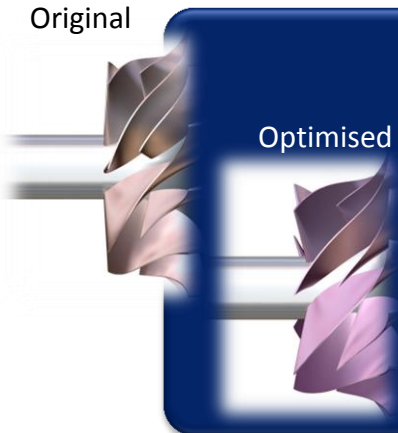

Optimised

Applications:

- Aeronautics & Space
- Turbomachinery
- Hydro
- Energy
- ...

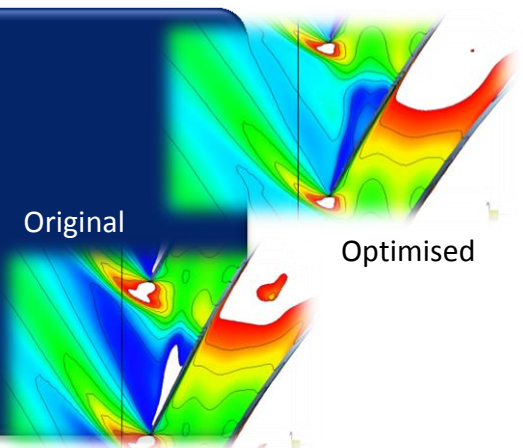

Original

Optimised

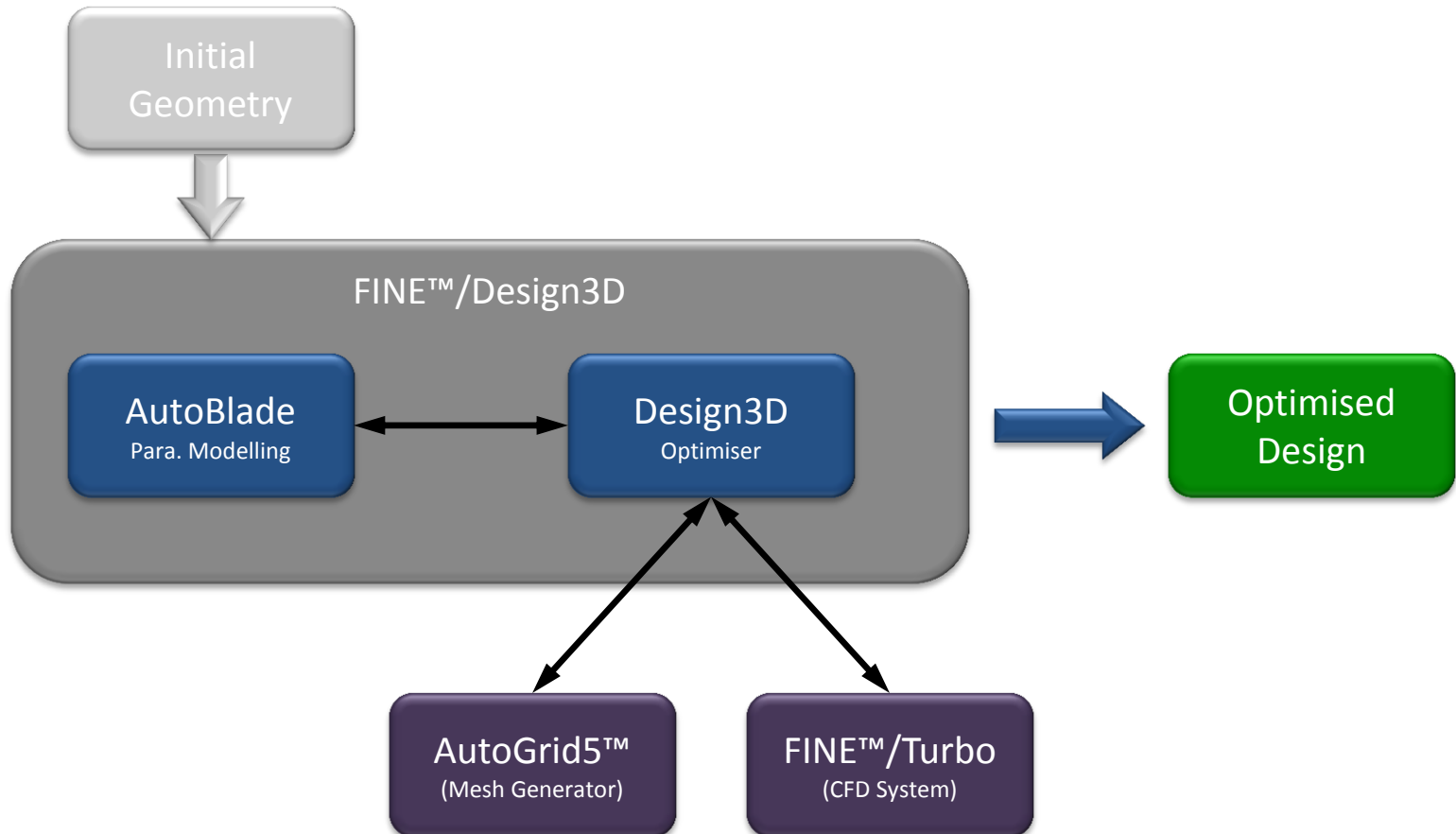

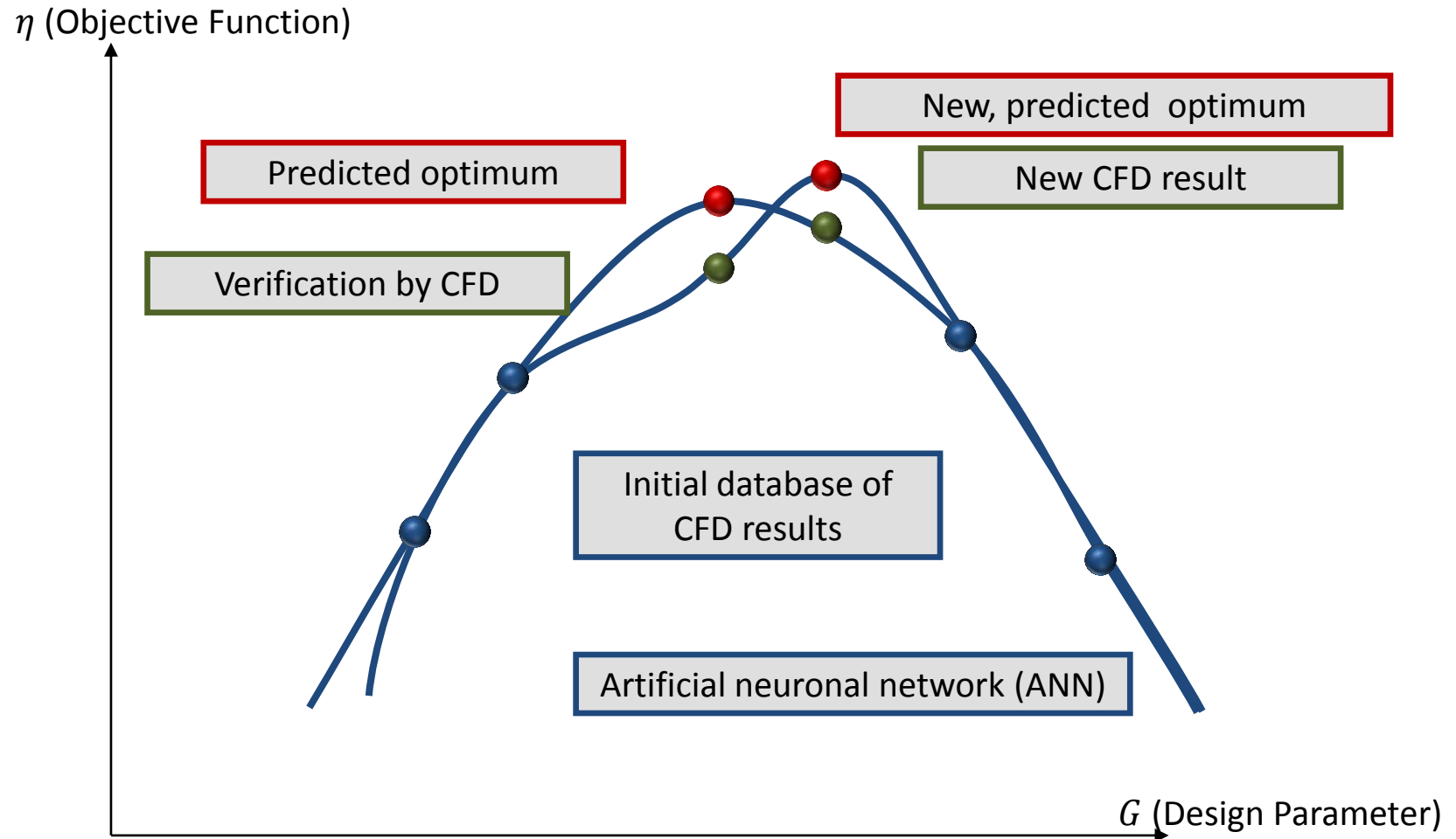
Step 7: CFD Verification of Improved Parameter Combination

2

Case: LP Steam Turbine & Exhaust Casing

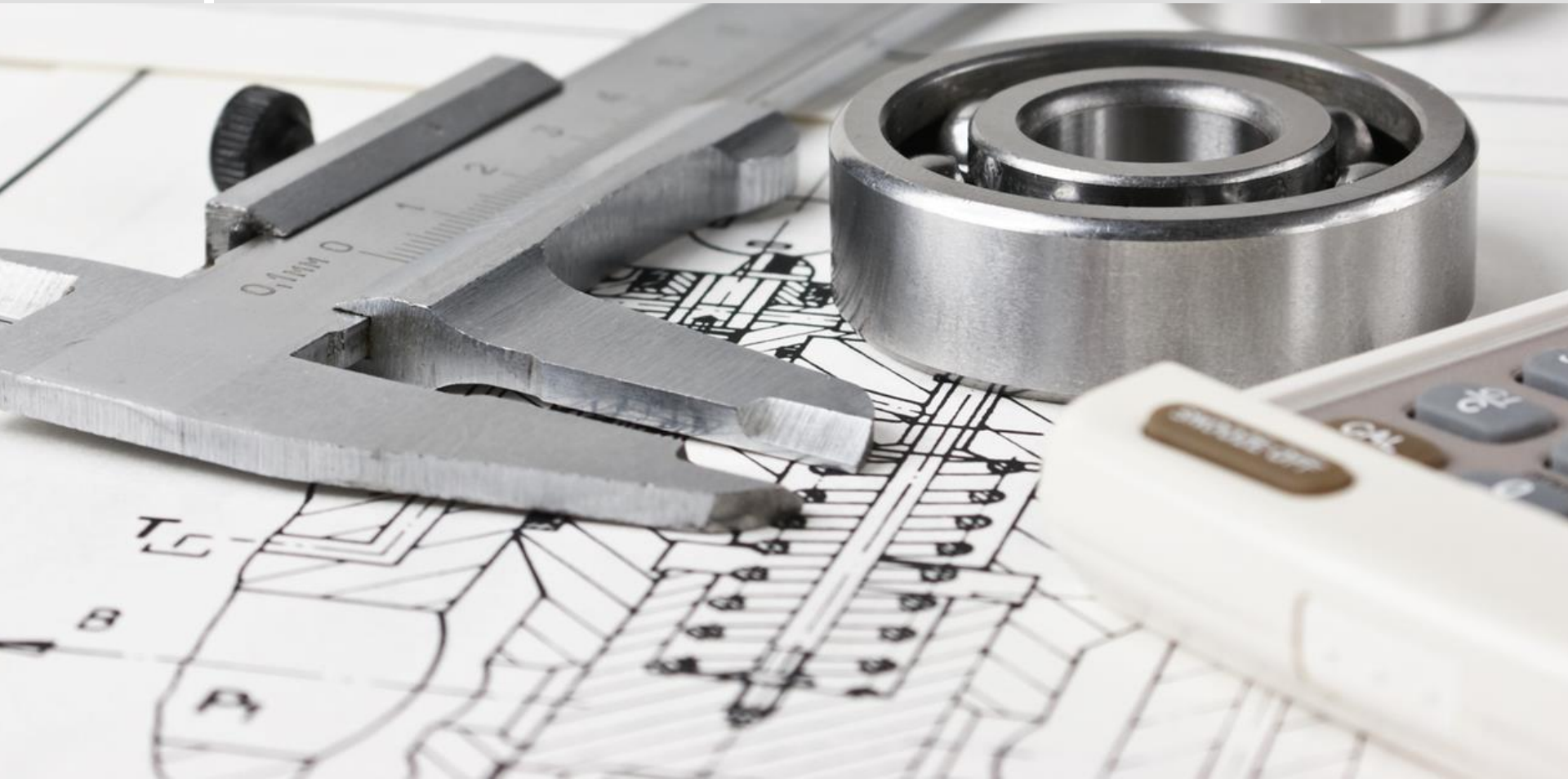

USC 660 MW Turbine

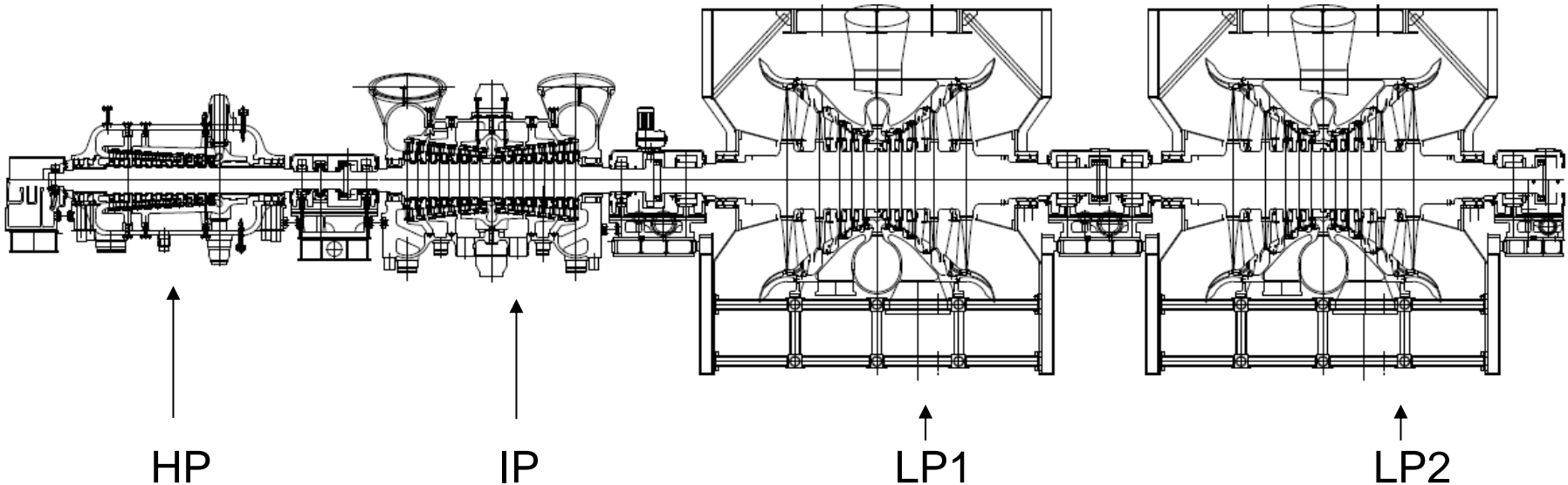

Total turbine length to LP 2 flange > 30000 mm
Overall weight ~1100 t

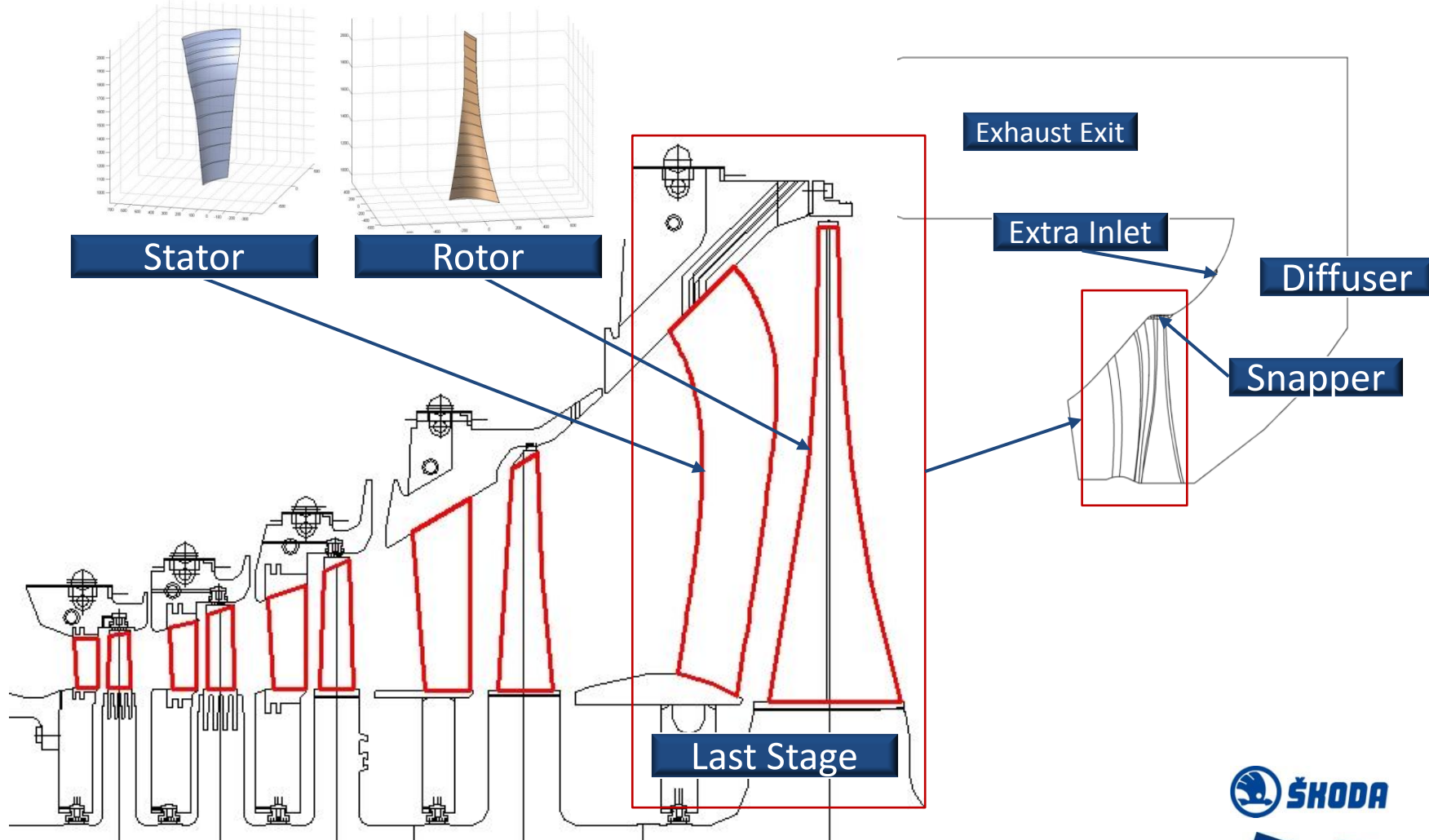

USC 660MW – Low Pressure Turbine Part

- Main goal: increase global efficiency & maintain mass flow
- Four operating points per design

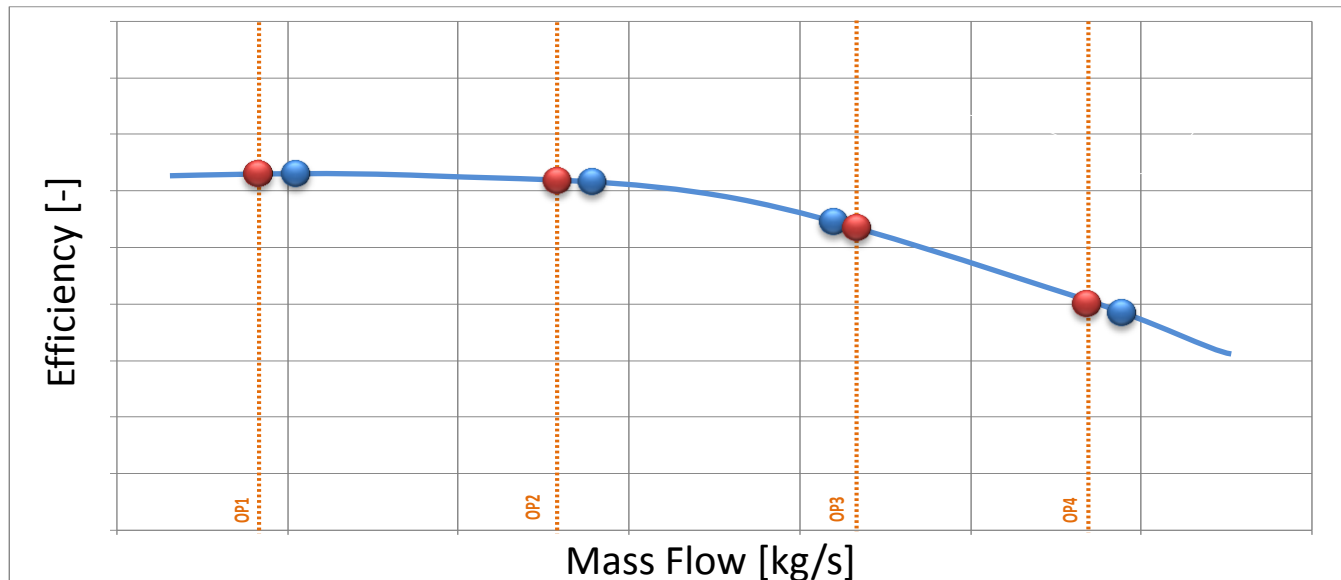

 Operating point by Polynom
  Operating point by FINE/Design 3D

 $\eta_{TSMK,opt}$ for the sample by weighting function

- Main parameters:

- 7 parameters sweep
- 7 parameters lean
- 7 parameters hub

Blade Shaper

- 10 parameters for shape of the diffuser

AutoBlade™

- Constraints:

- Polylines at the diffuser hub
(welded construction)

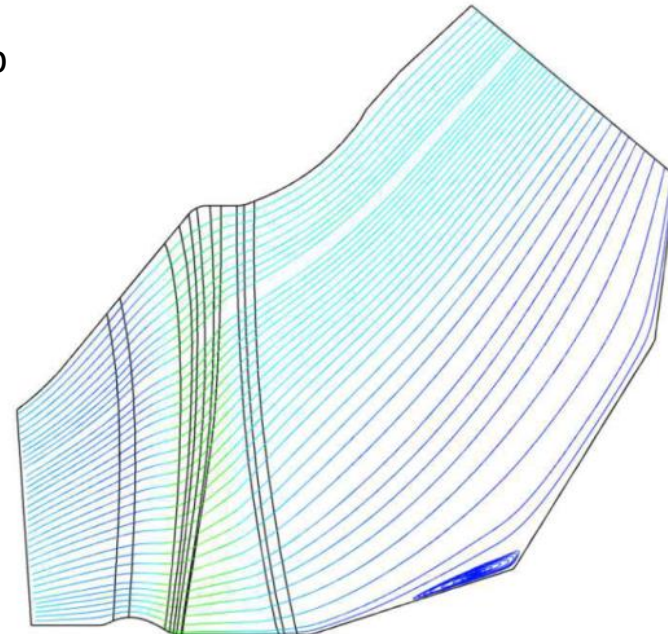

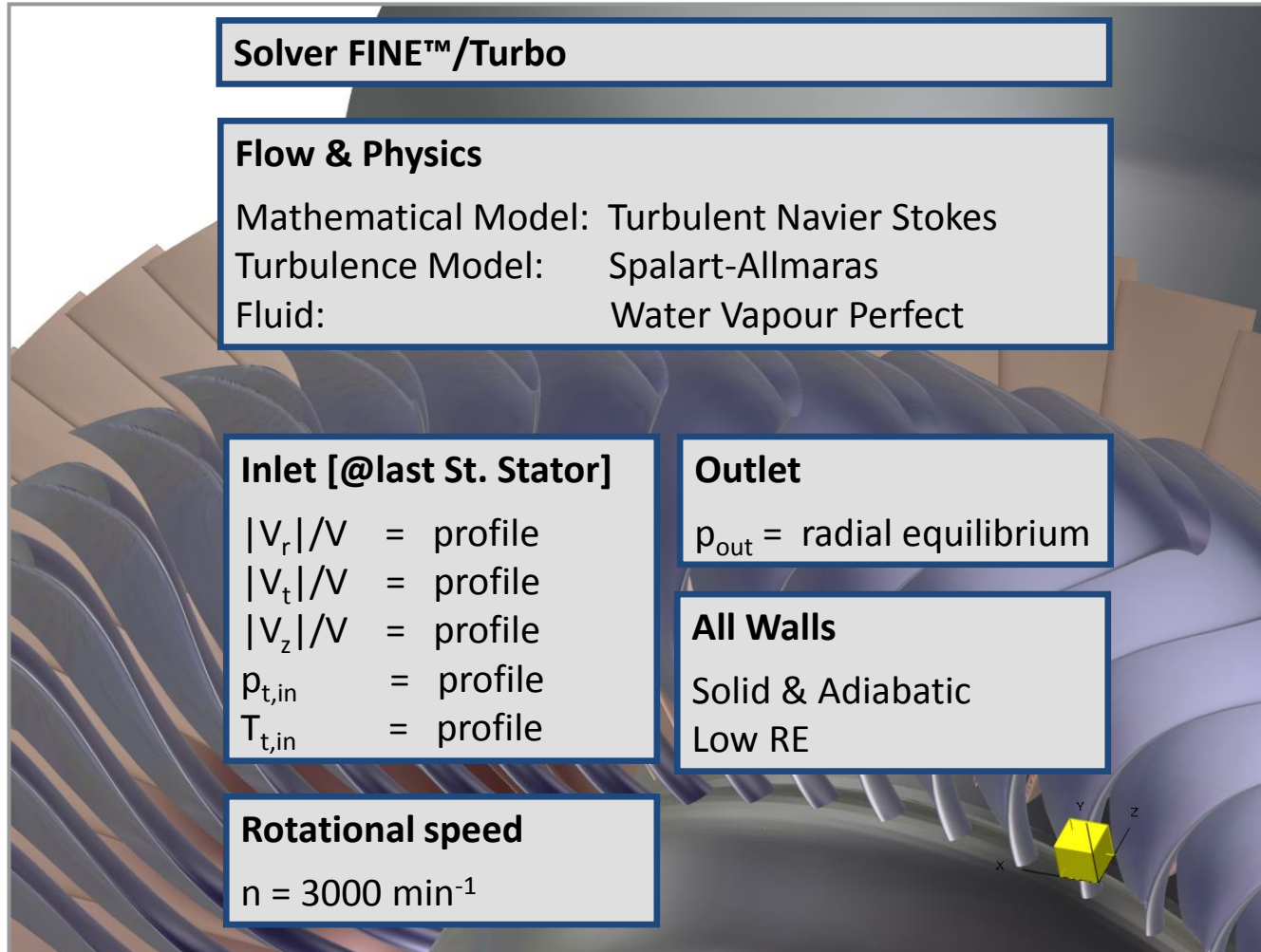

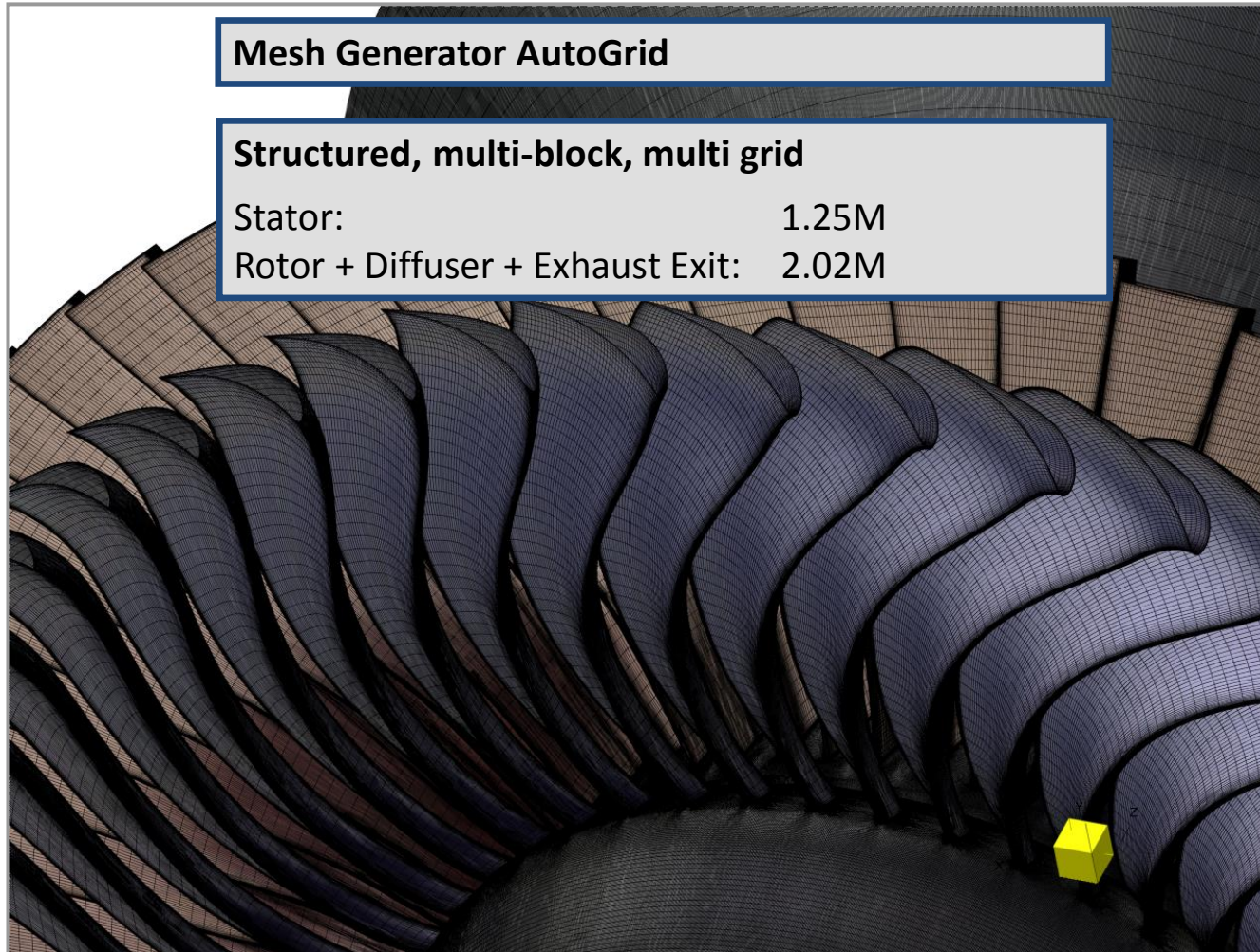

3

Results: Database

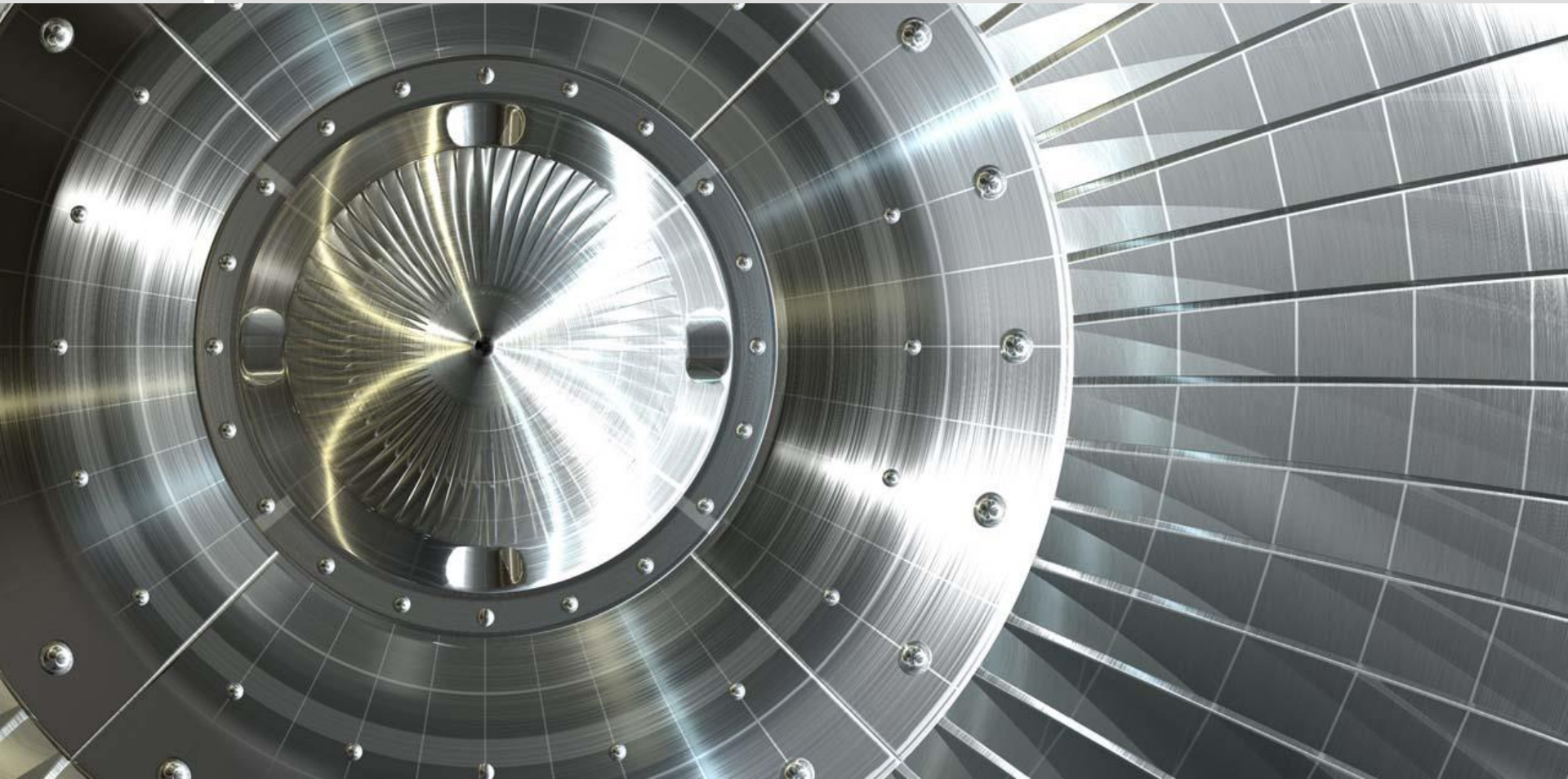

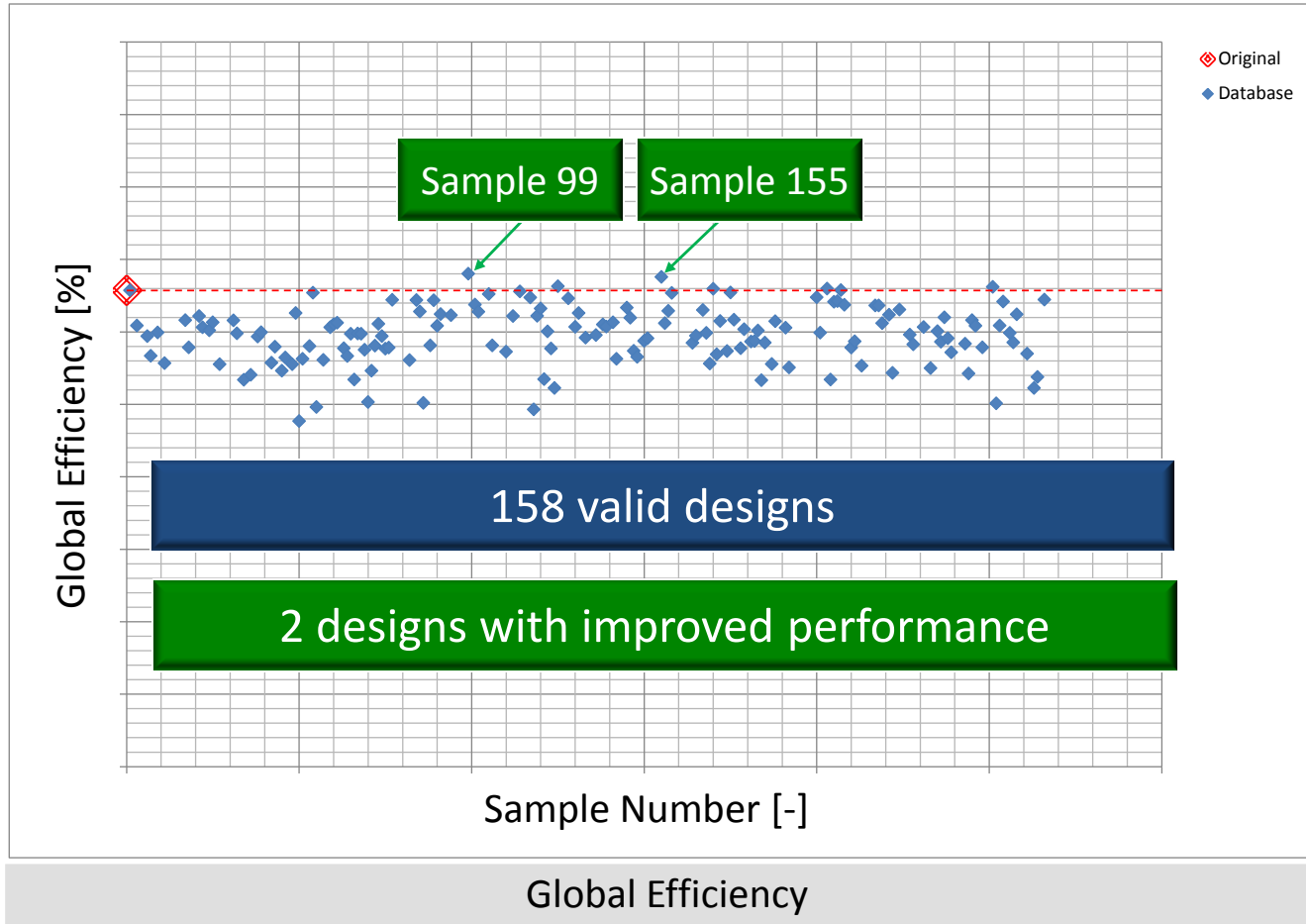

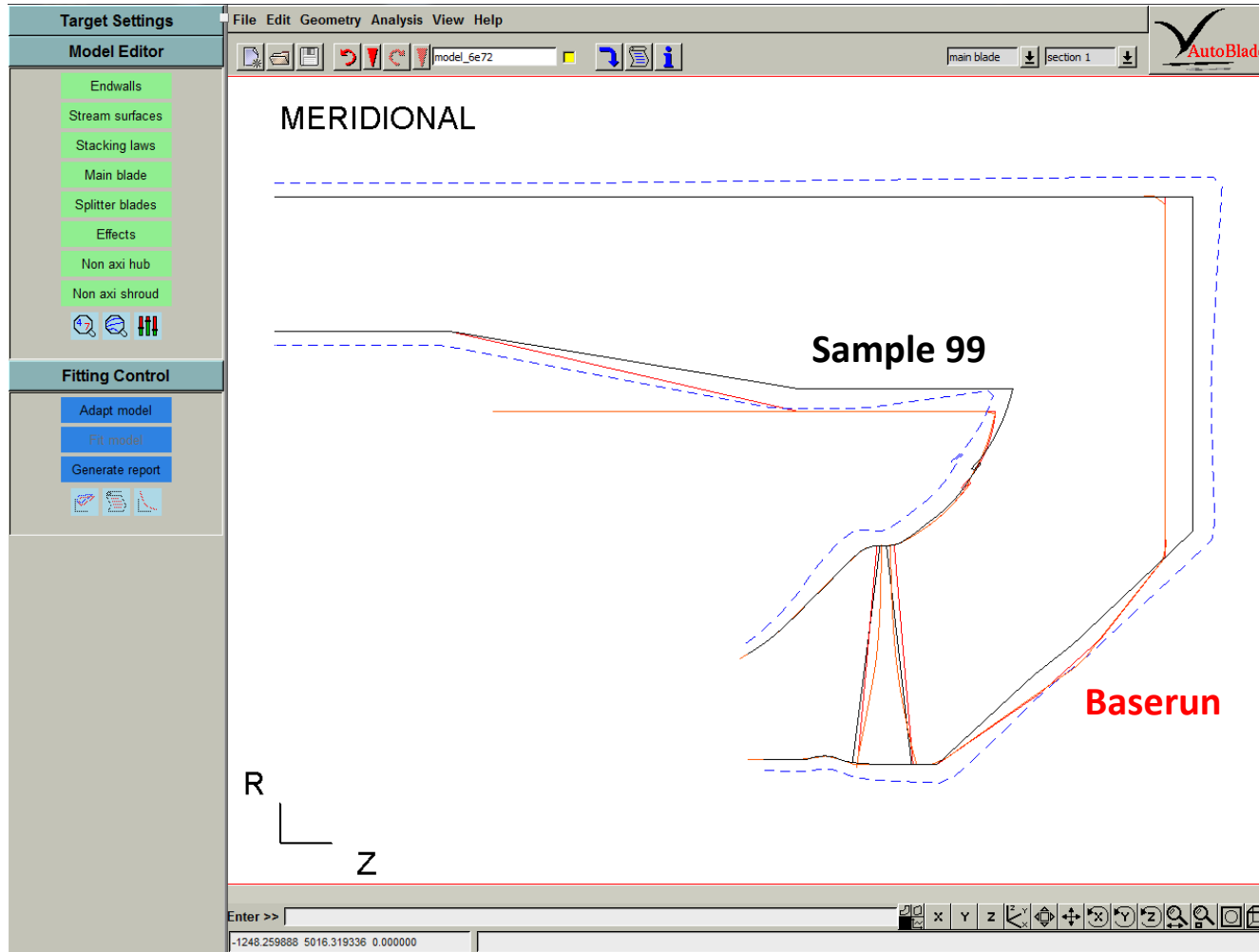

Meridional geometry Sample 99

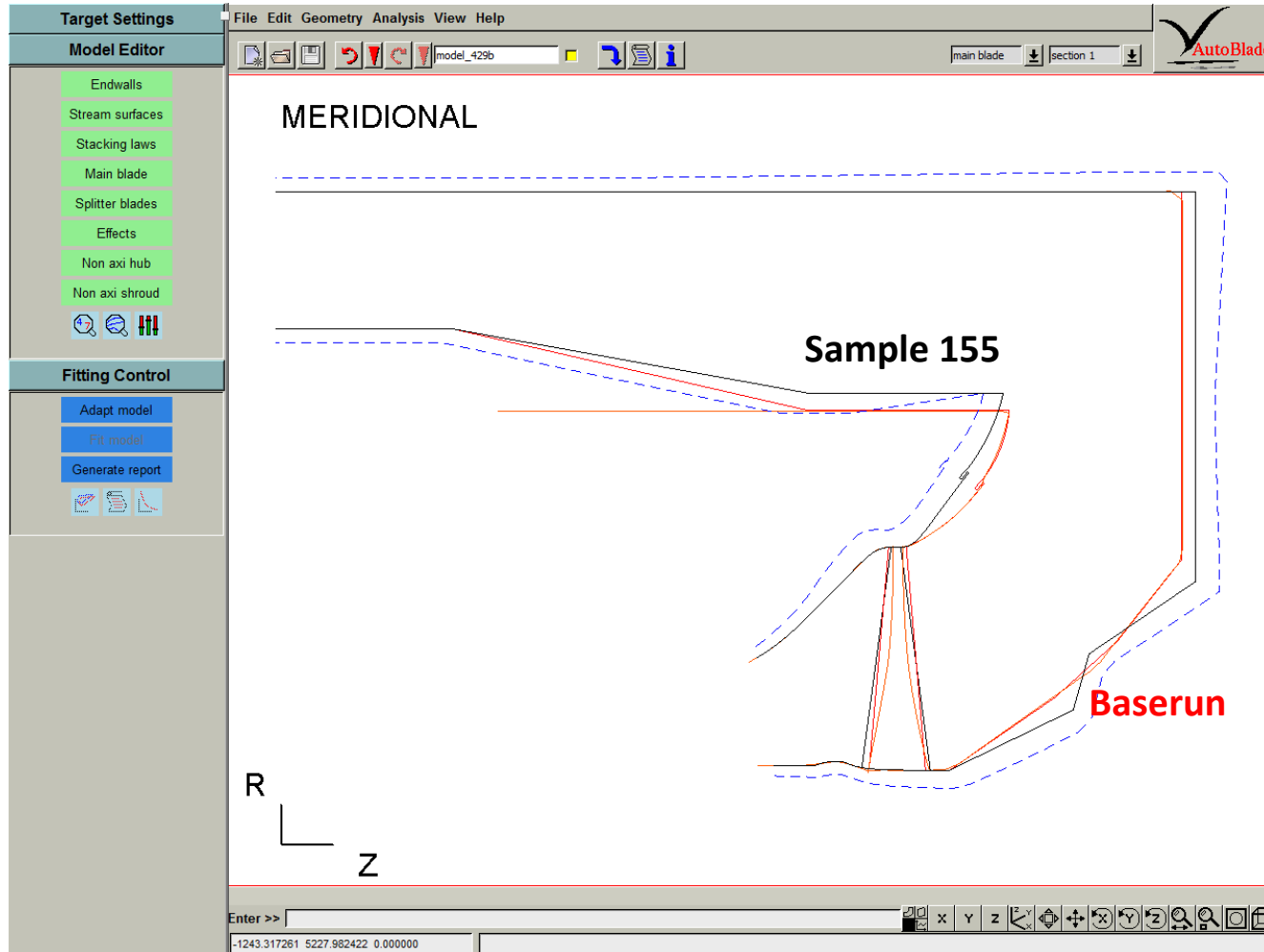

Meridional geometry Sample 155

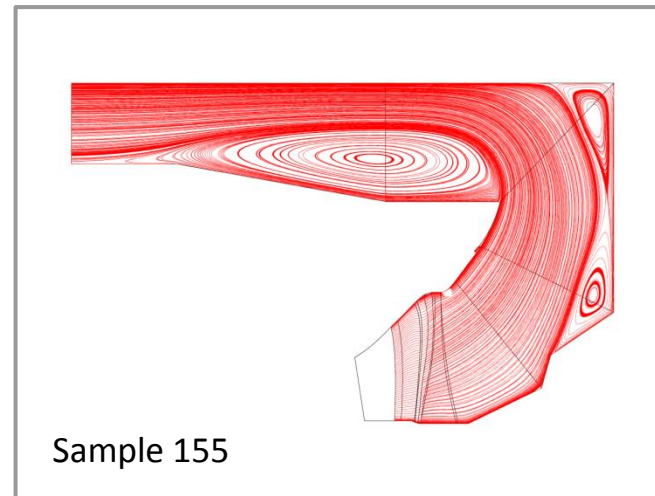
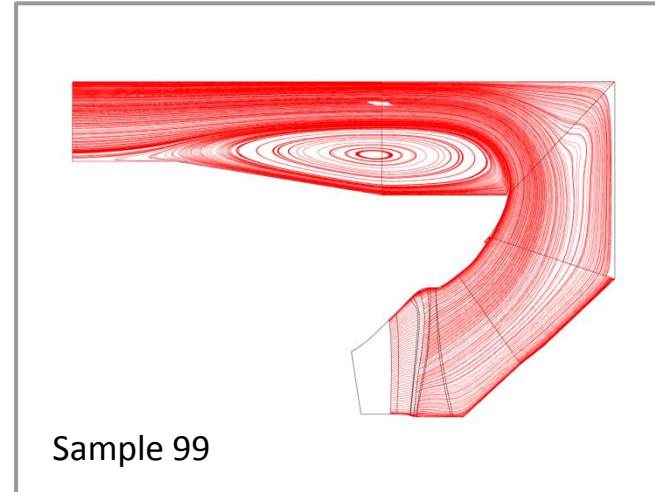
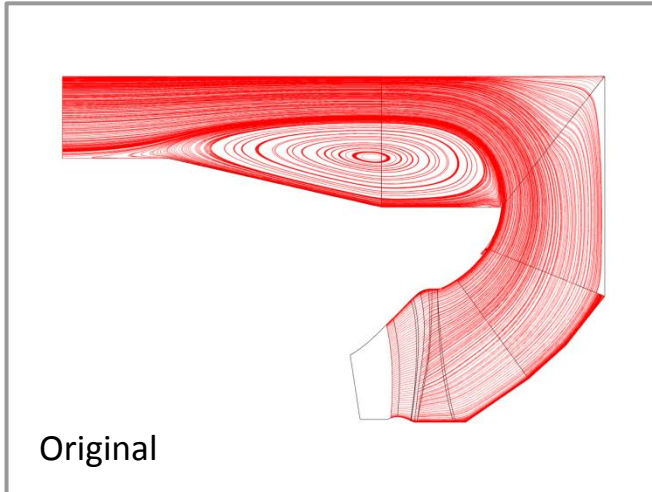

Streamlines: Original & best designs in Database

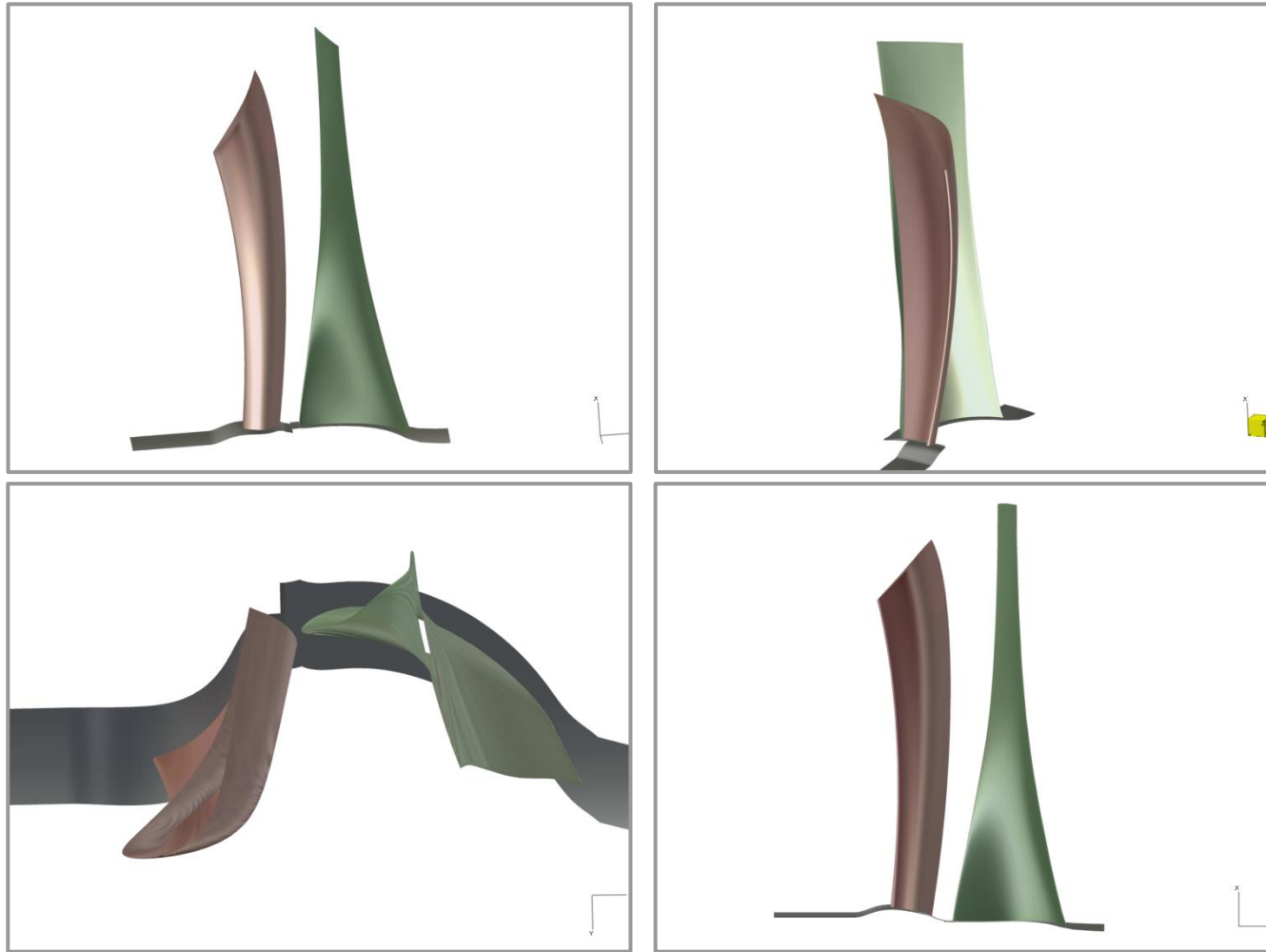

Original

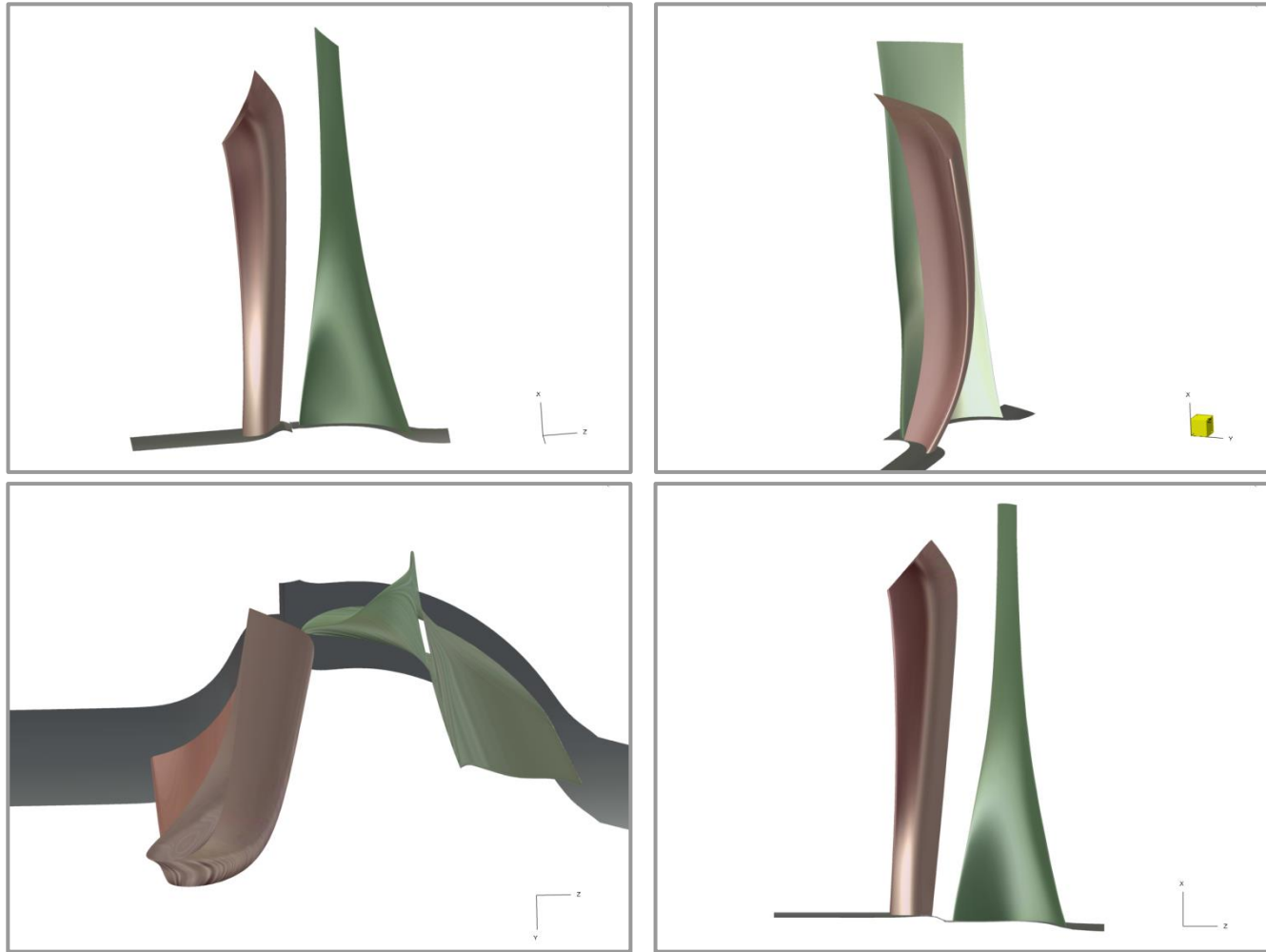

Sample 99

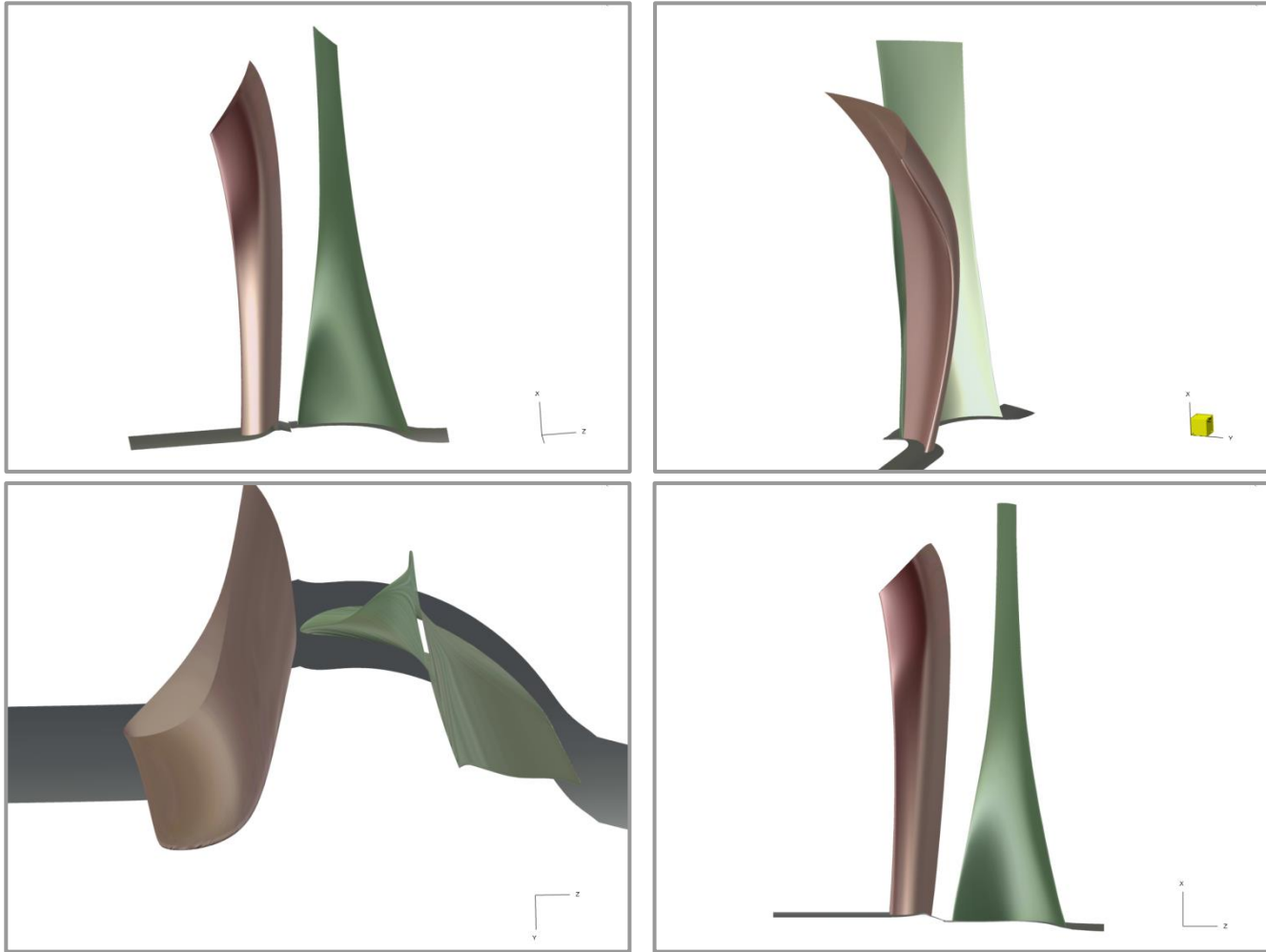

Sample 155

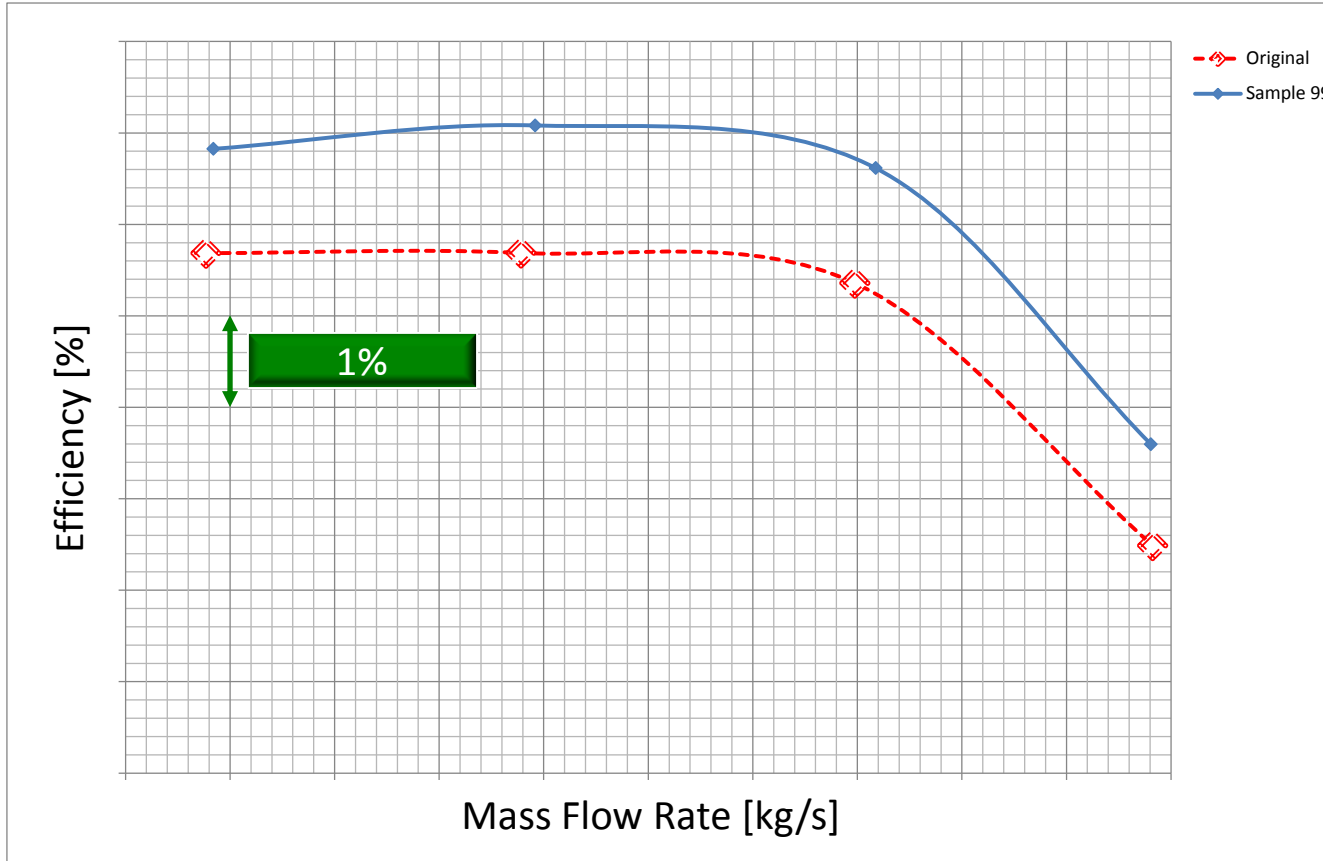

Original Design vs. Sample 99

4

Results: Optimisation





Database complete: Start Optimisation

OPT1: no mass flow restrictions

OP3 & OP4 critical: large increases in mass flow
led to lots of failed designs

OPT2 – OPT5: diverse constraints on mass flow
for different OPs

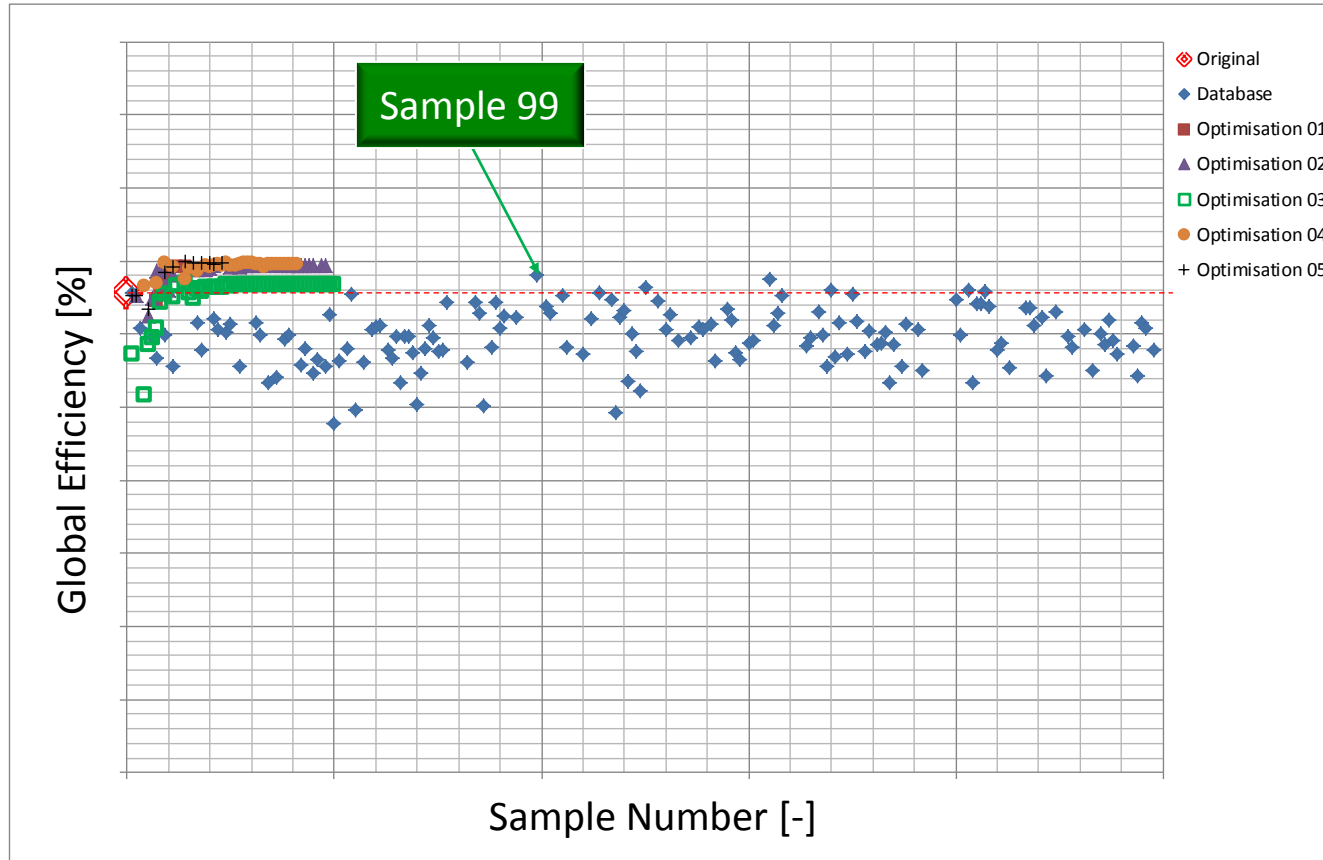

Global Efficiency Distribution in OPTs

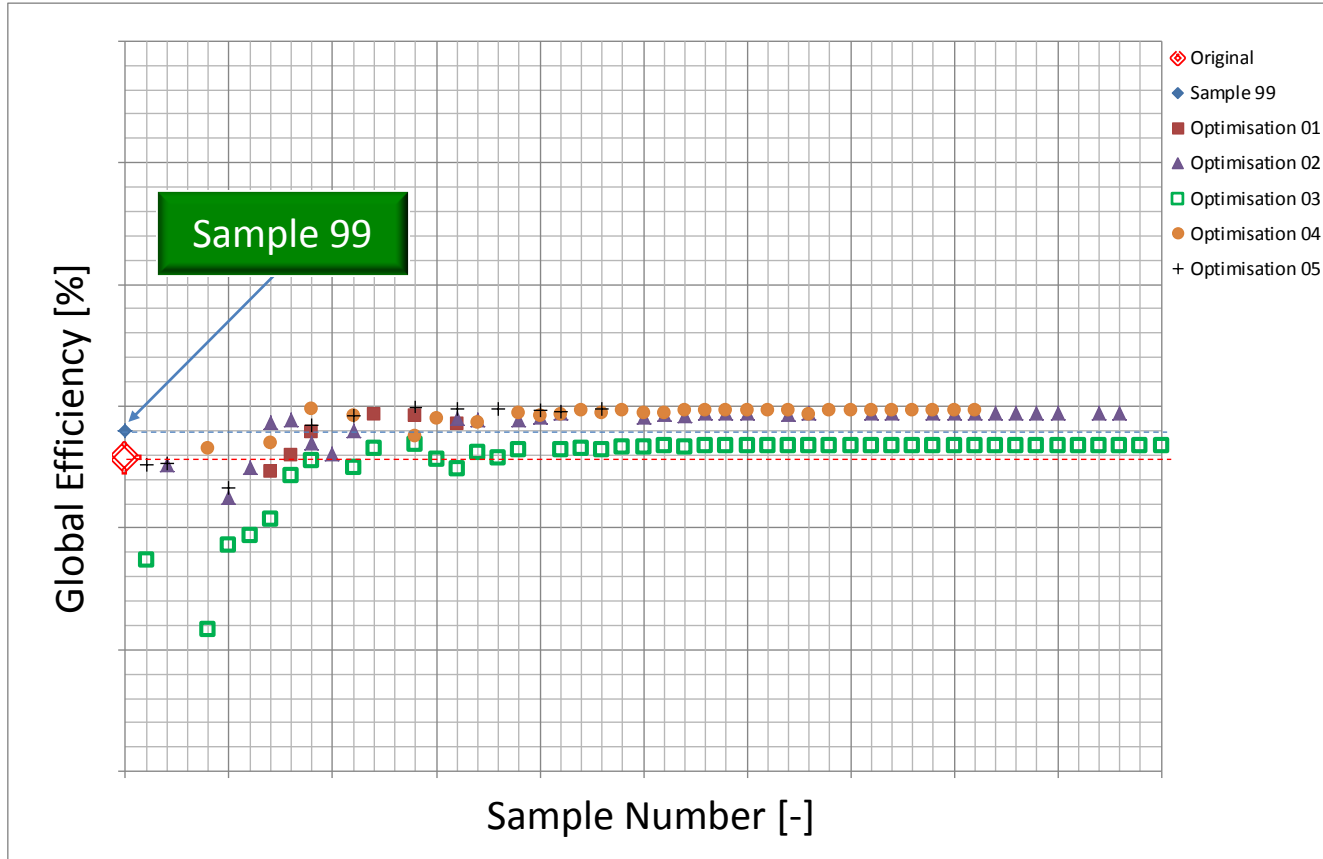

Global Efficiency Distribution in OPTs

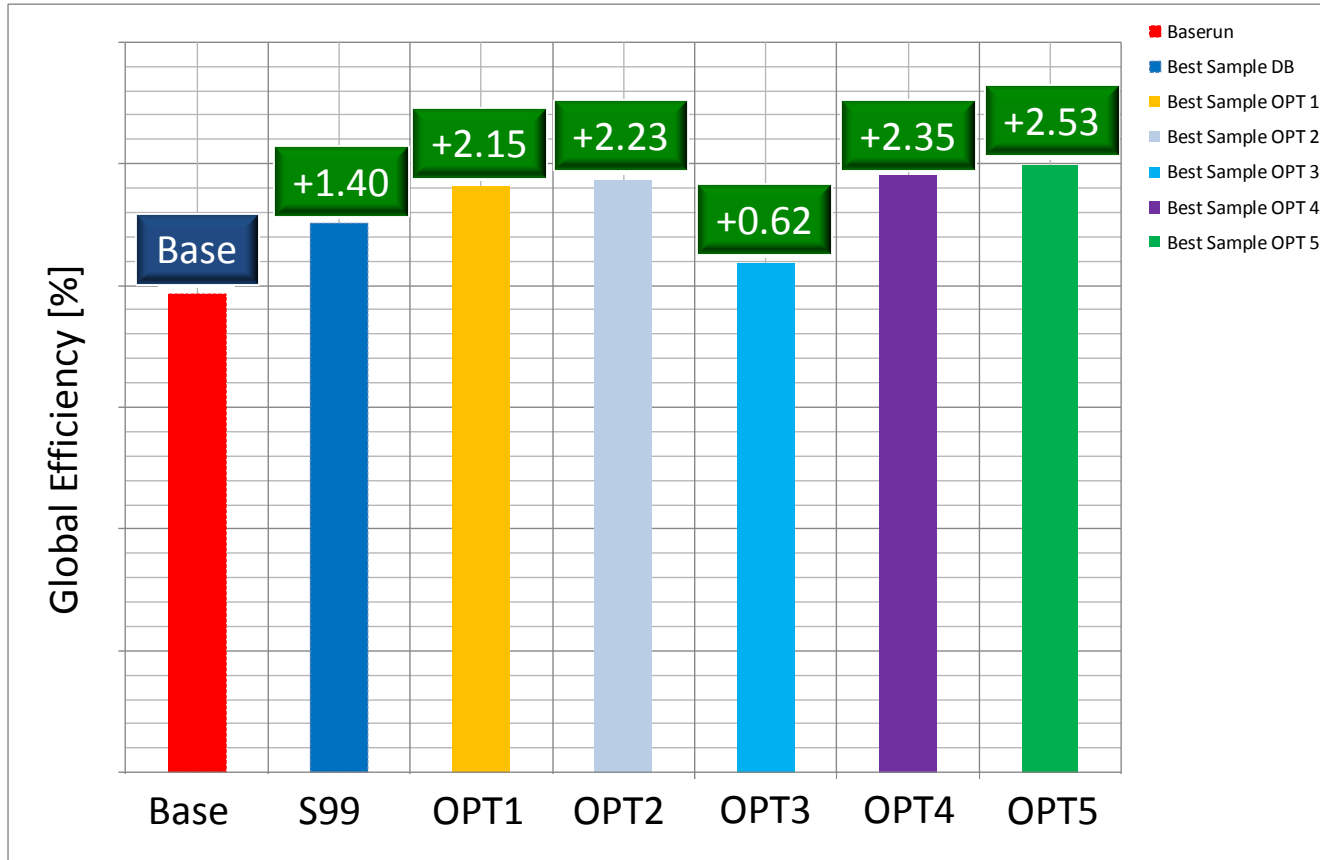

Global Efficiency: Original vs. Sample99 vs. best OPTs

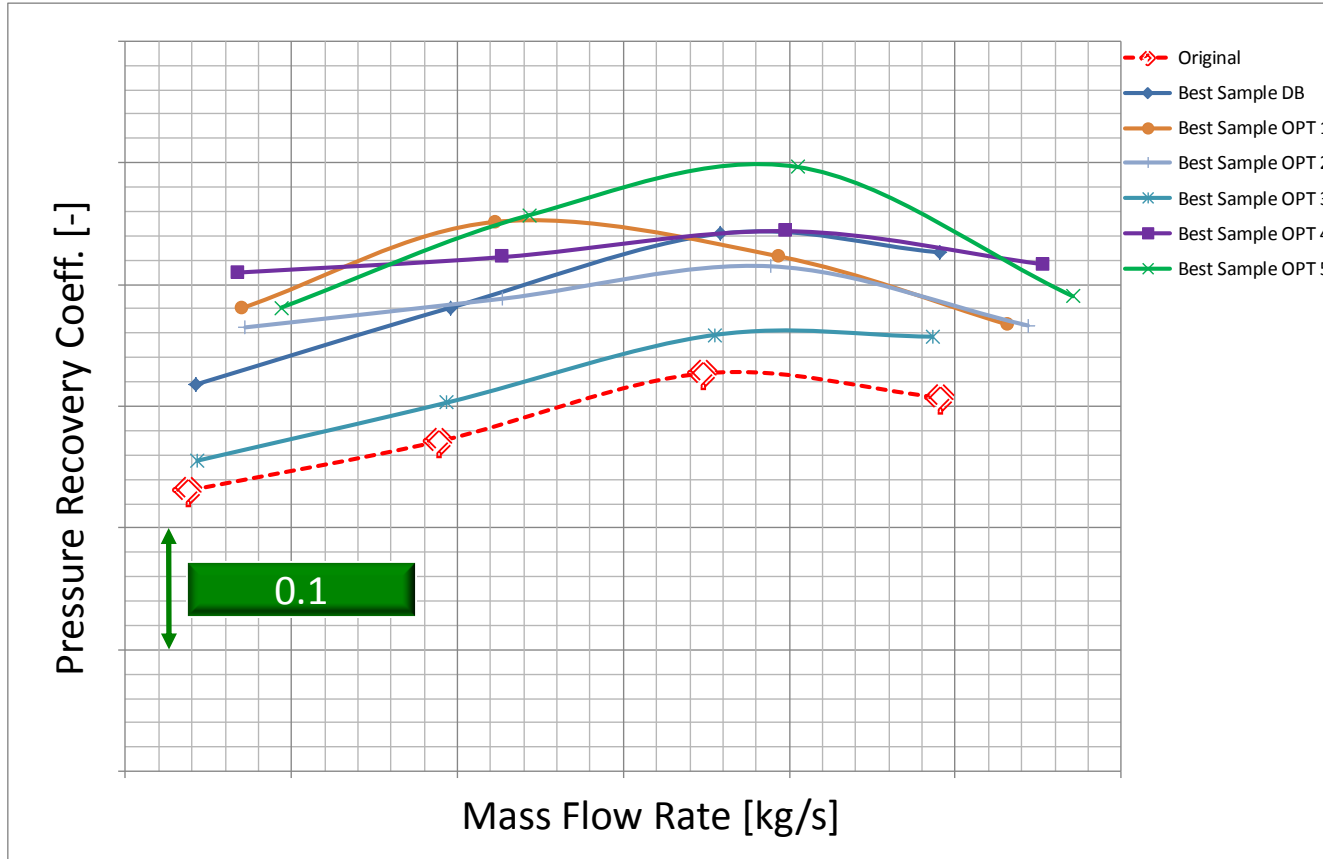

Pressure Recovery Coefficient

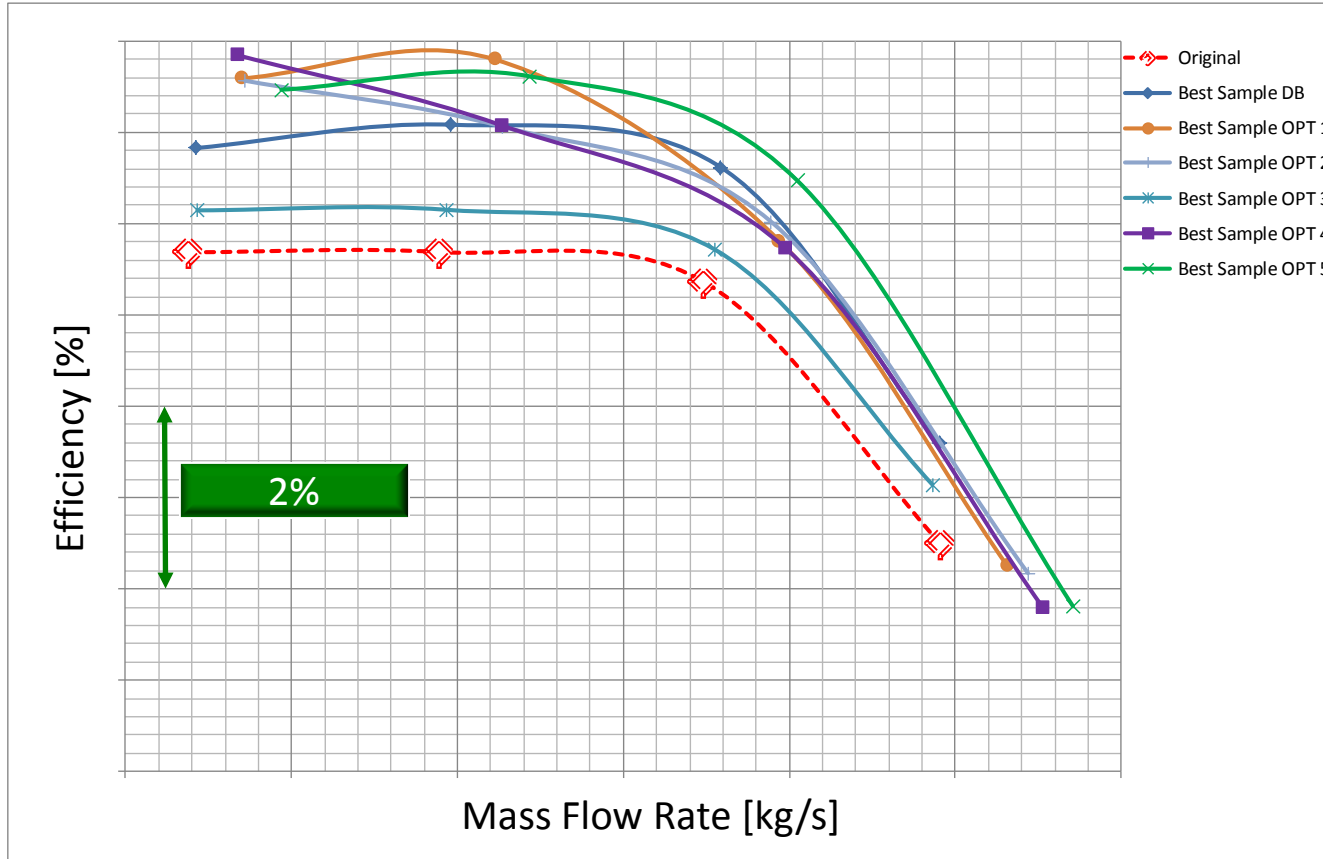

Efficiency of last Stage & Diffuser

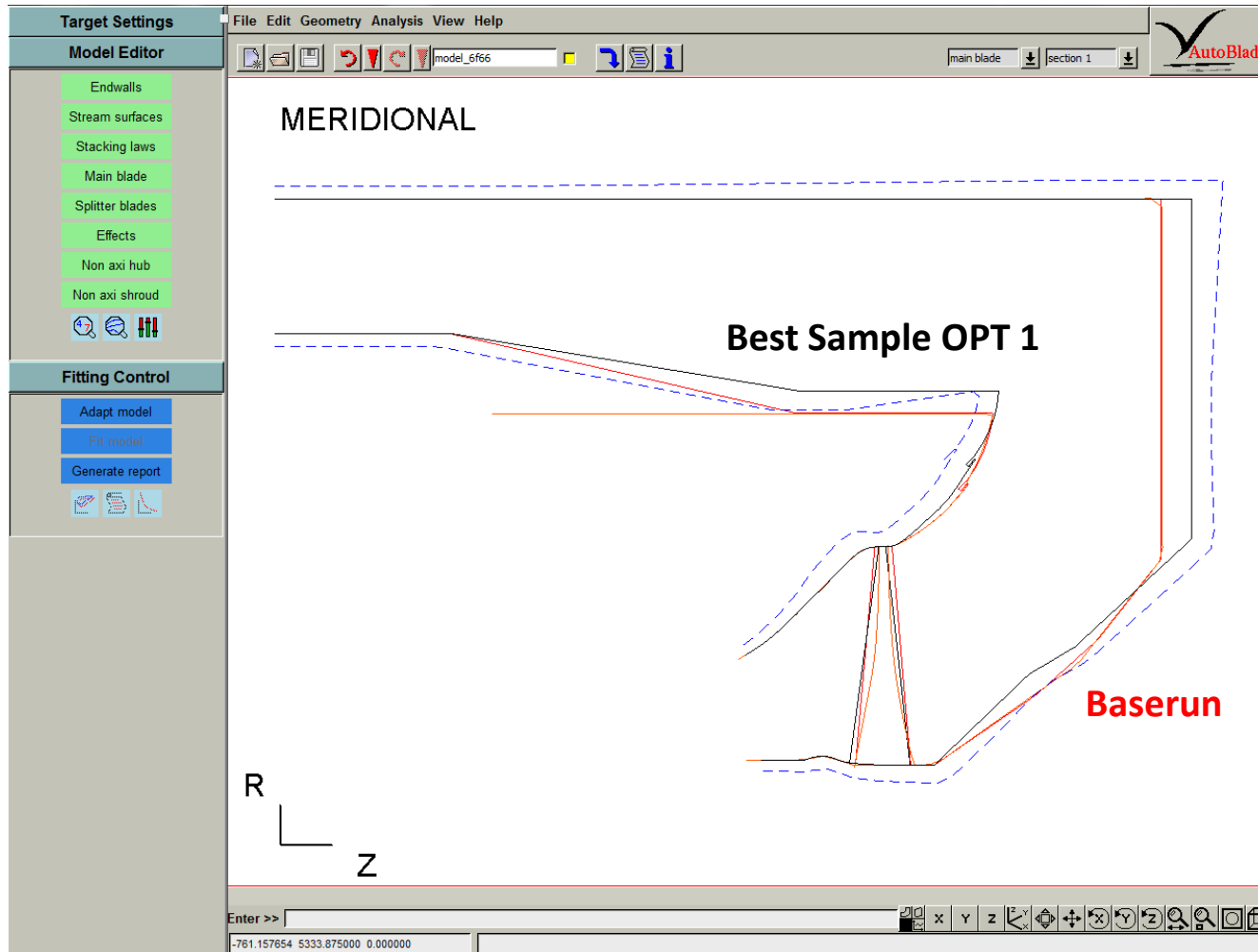

Meridional geometry

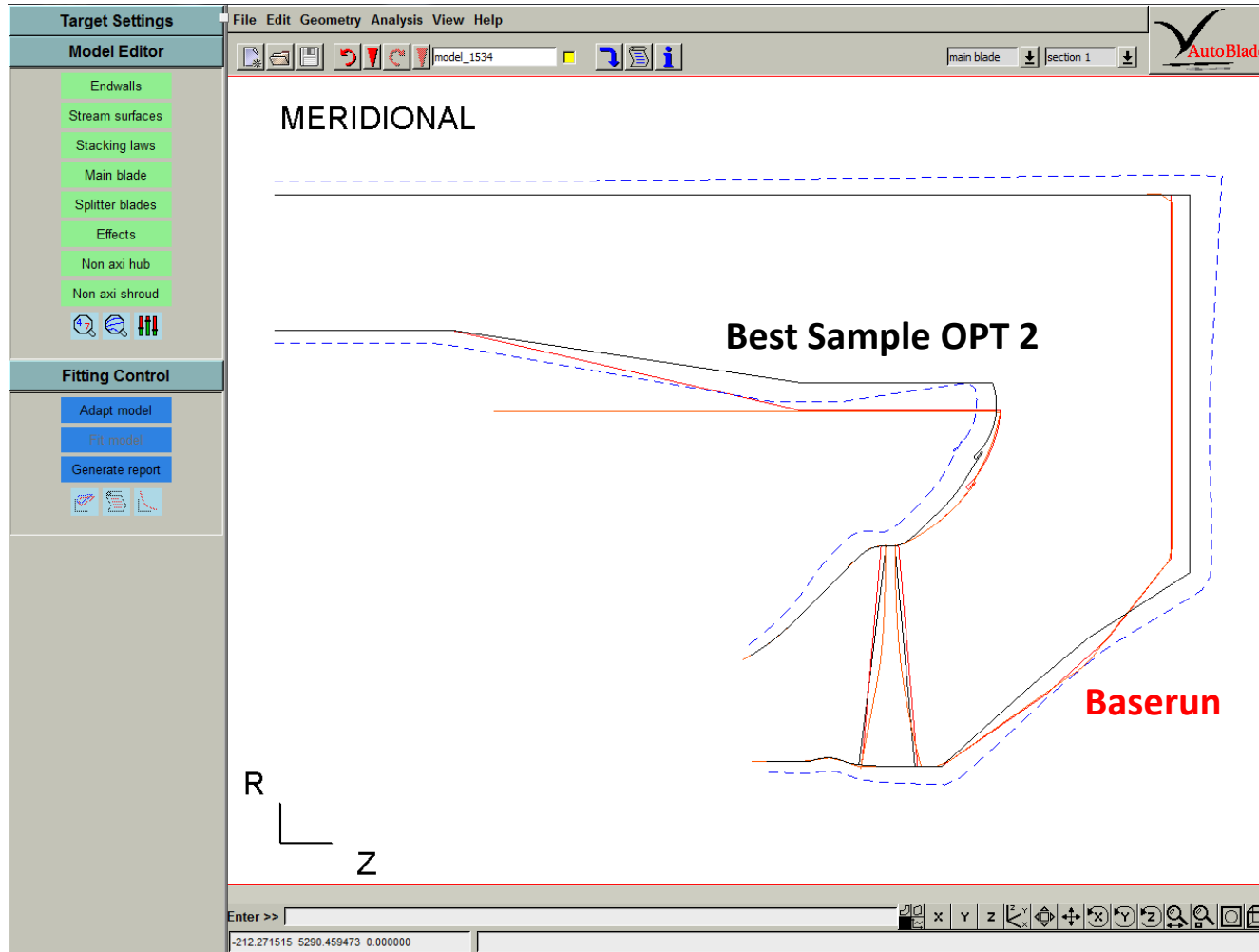

Meridional geometry

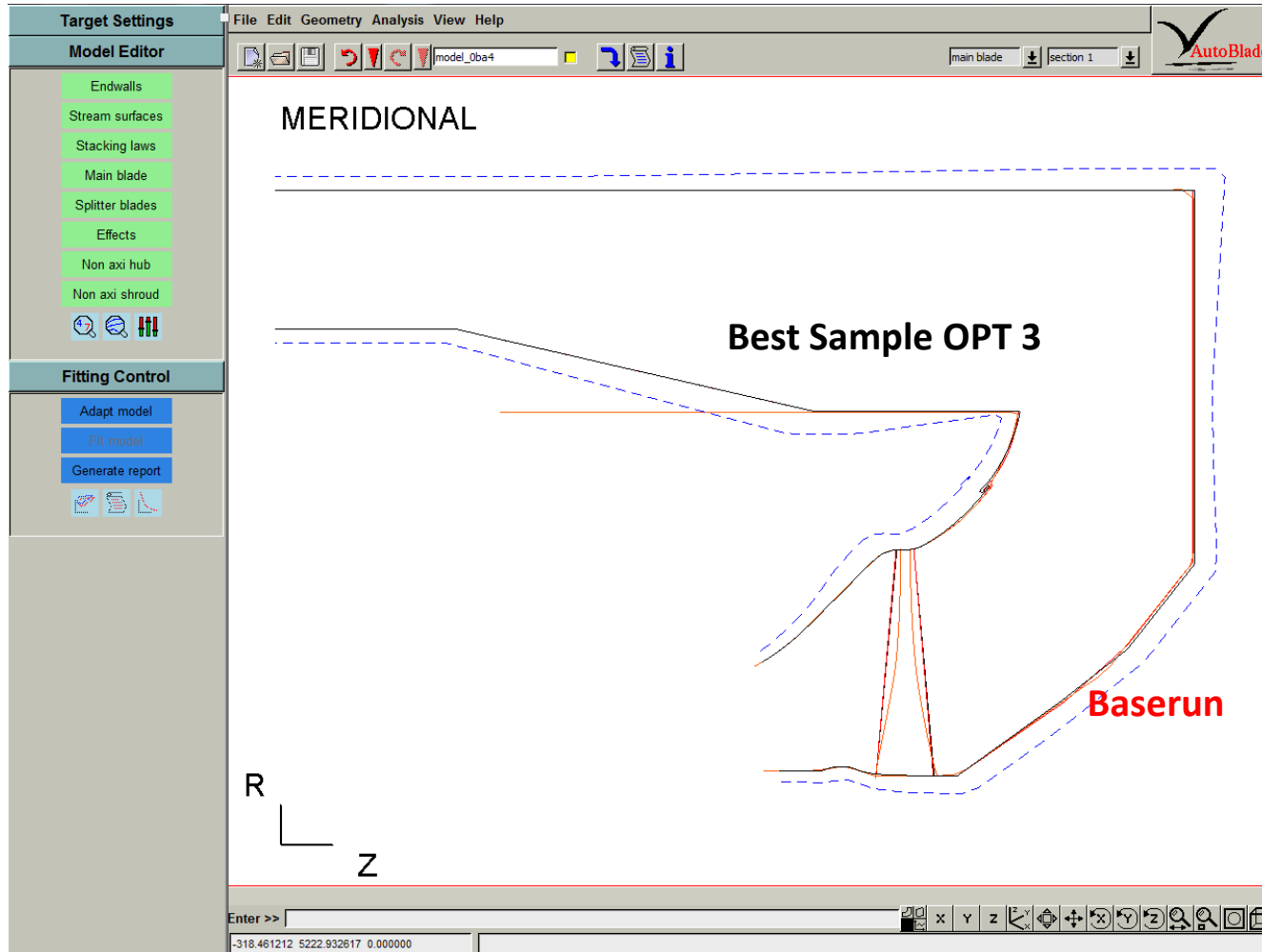

Meridional geometry

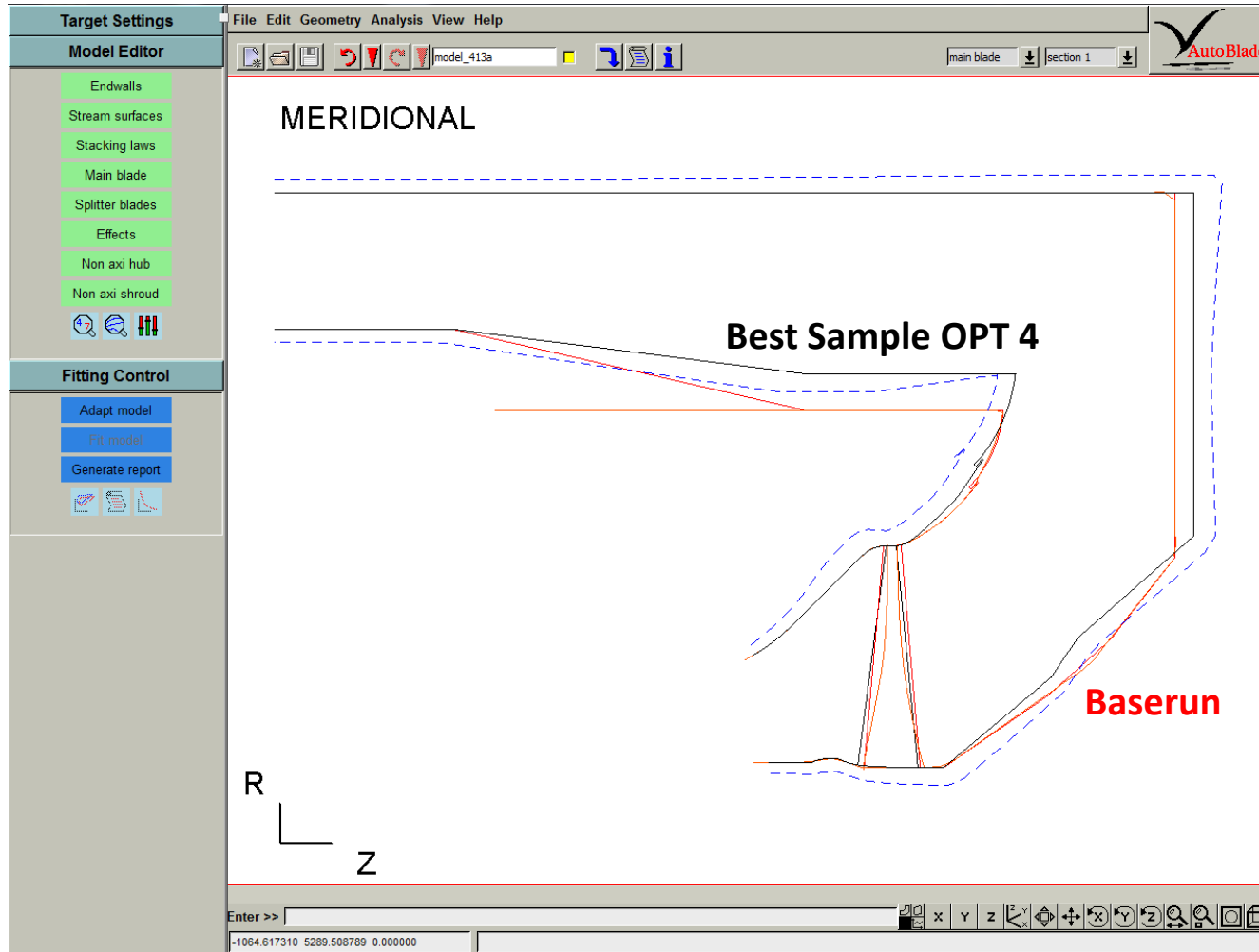

Meridional geometry

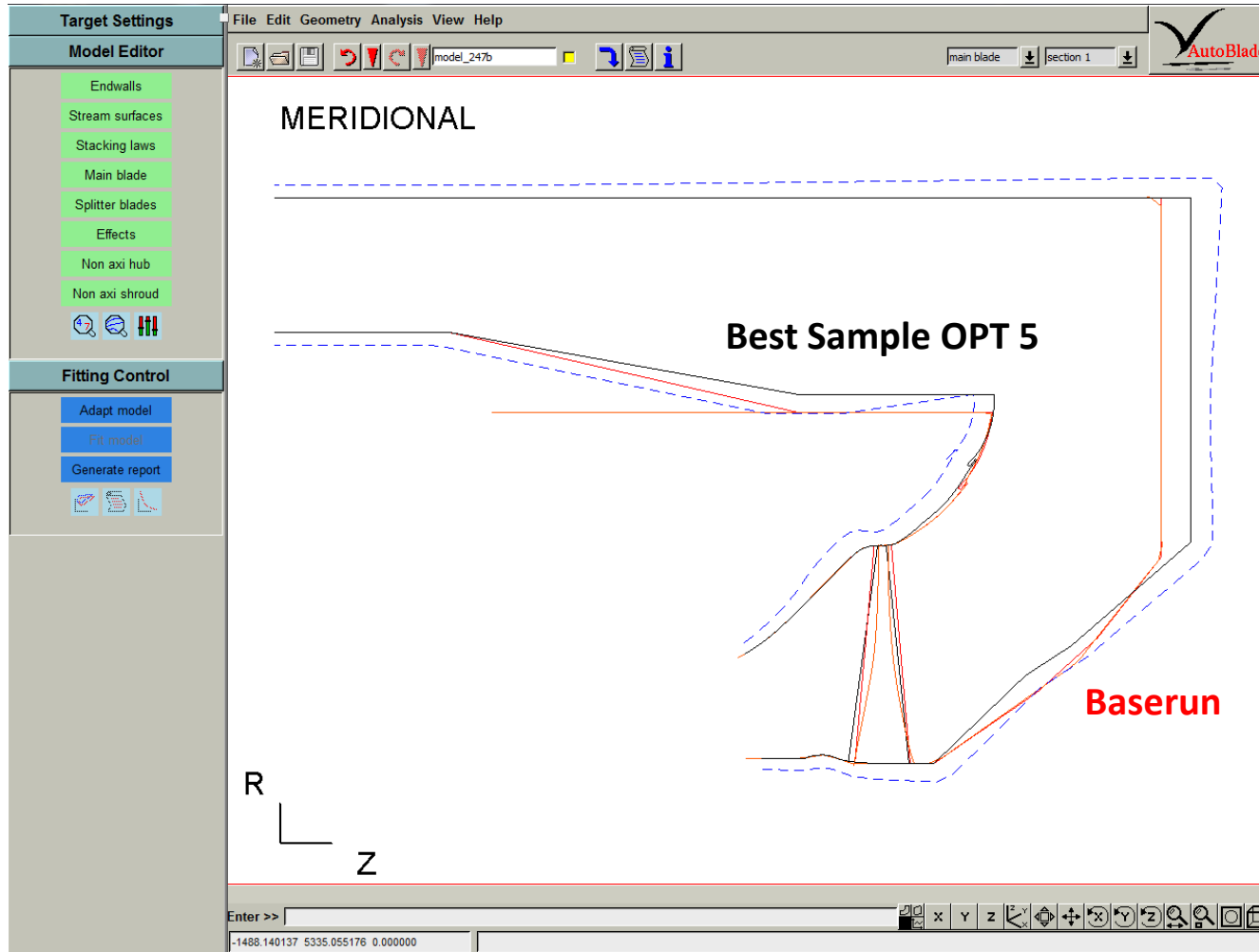

Meridional geometry

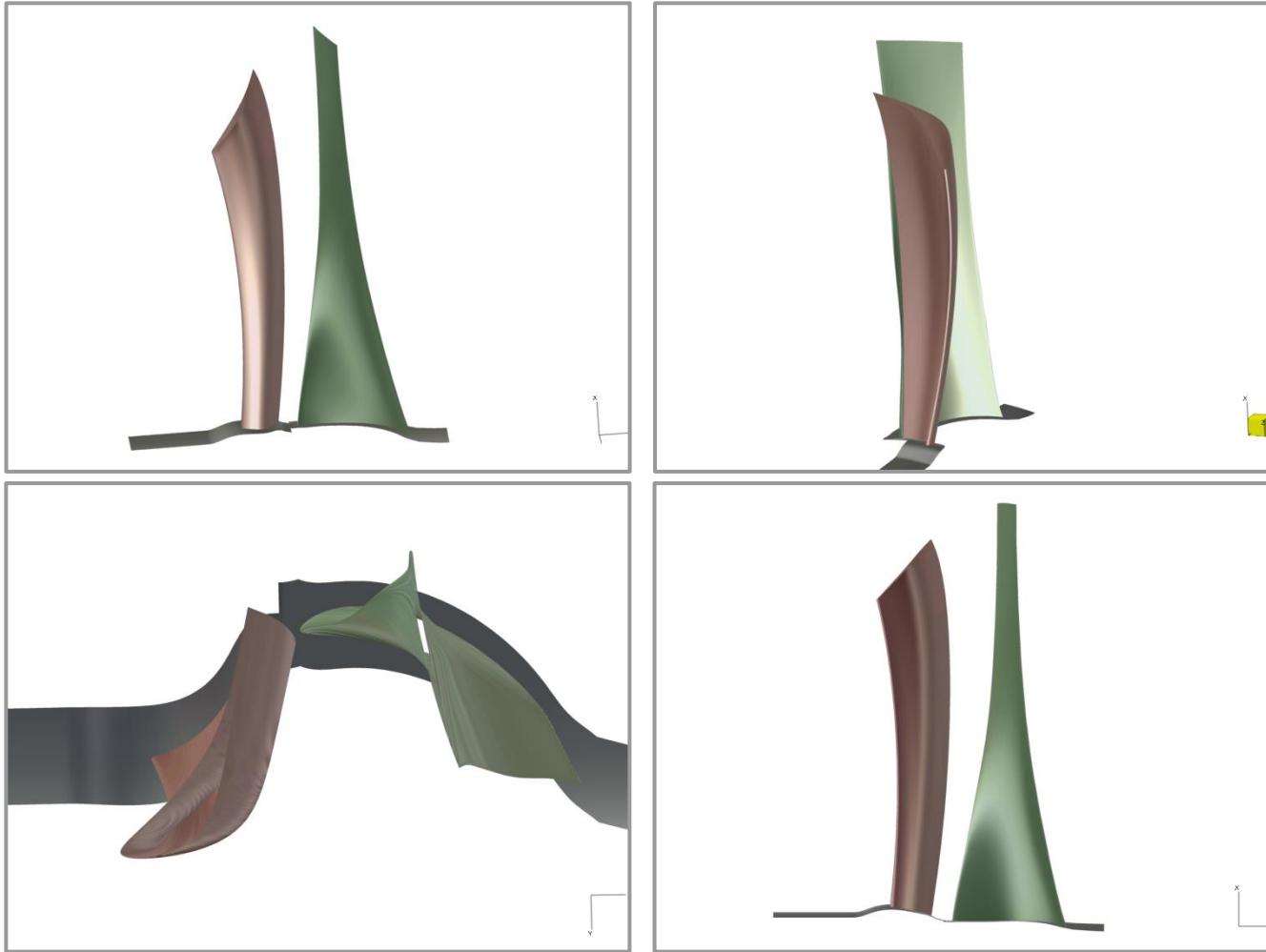

Original

4

Results: Optimisation Blade Geometry

Copyright
NUMECA
38

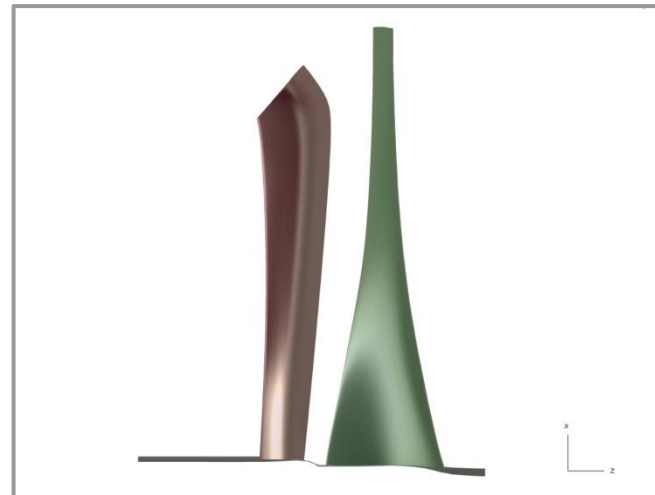
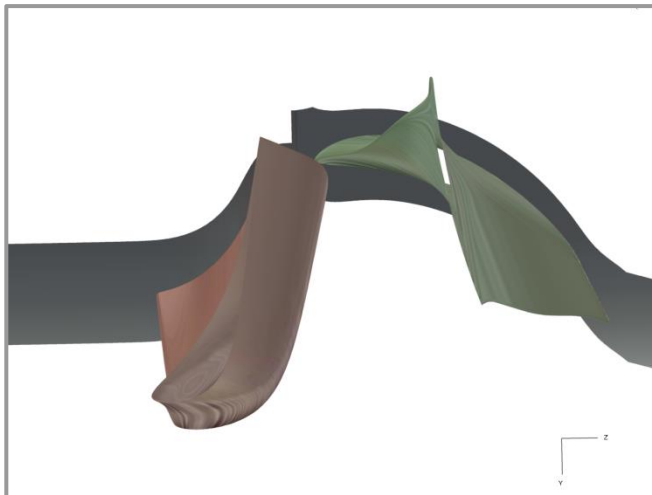
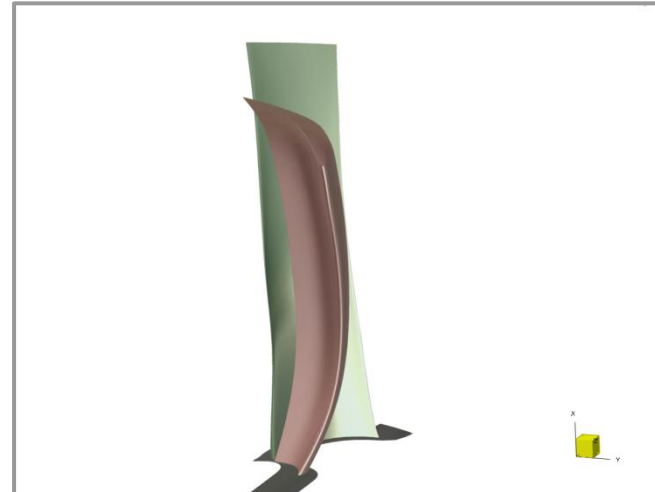
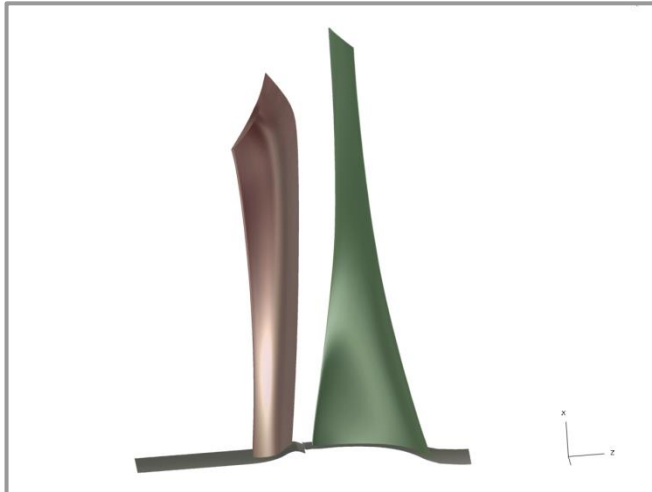

Best sample DB



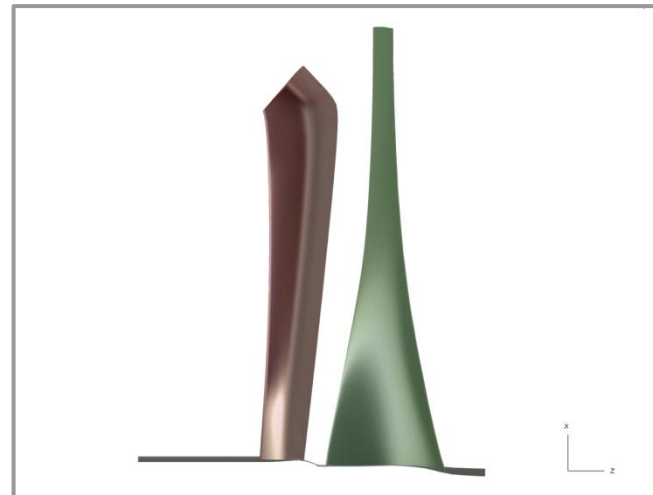
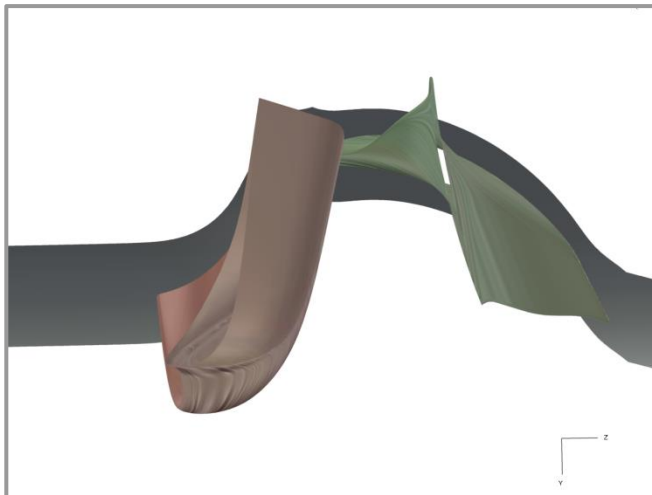
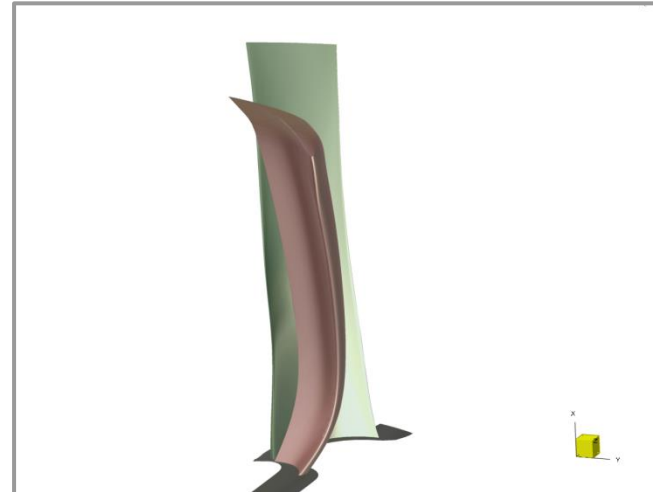
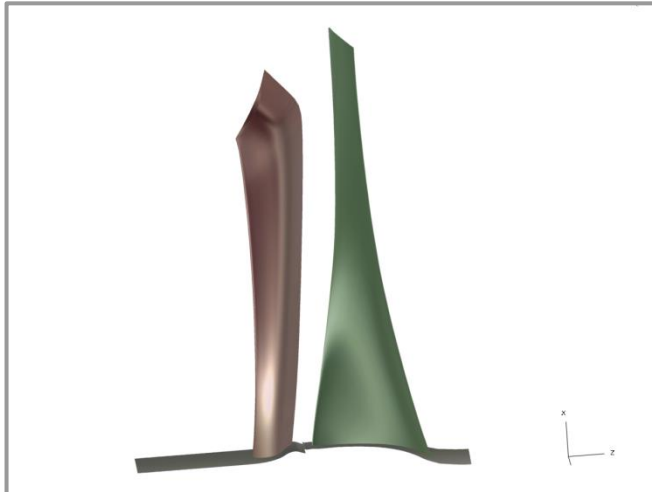

Best sample OPT 1

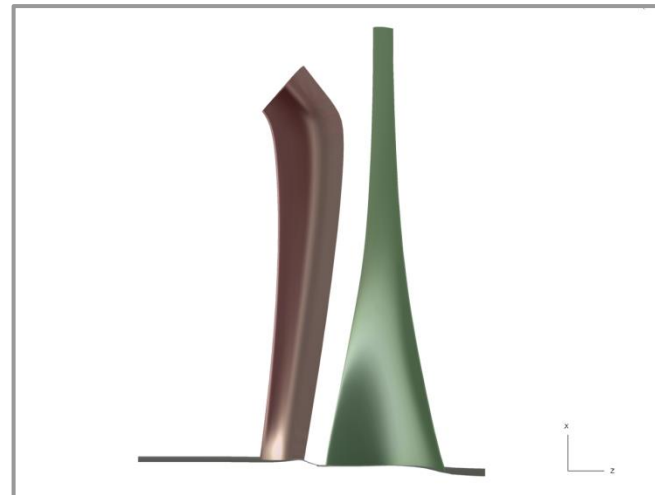
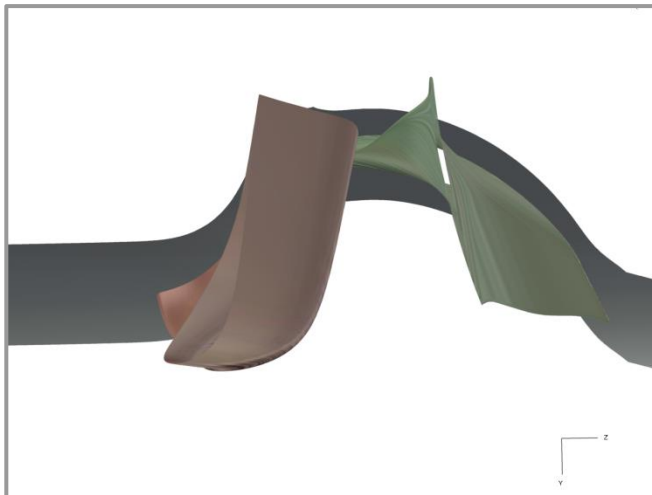
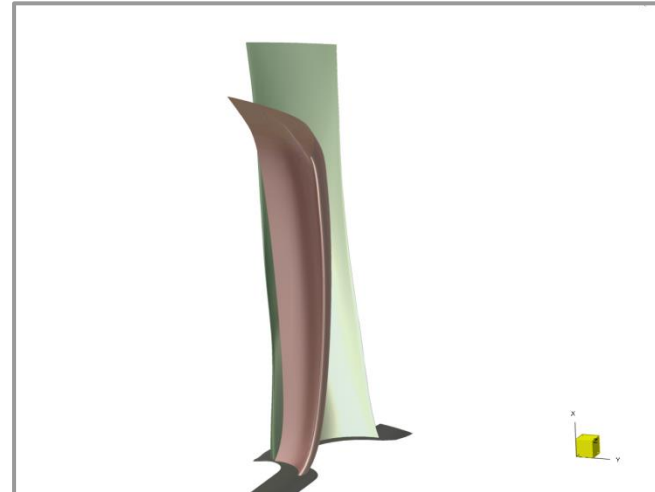
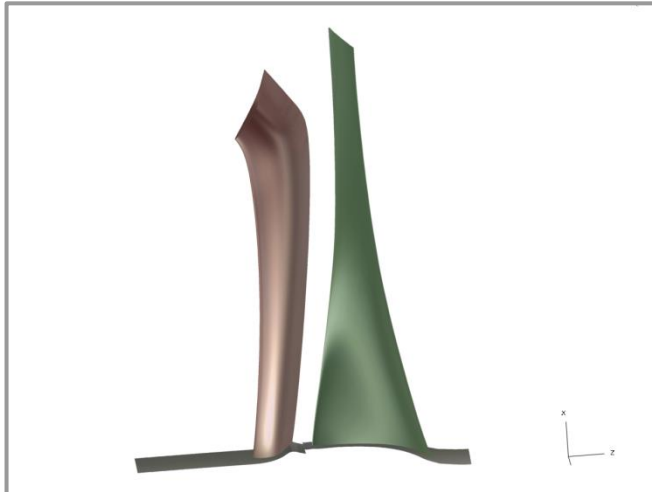

Best sample OPT 2

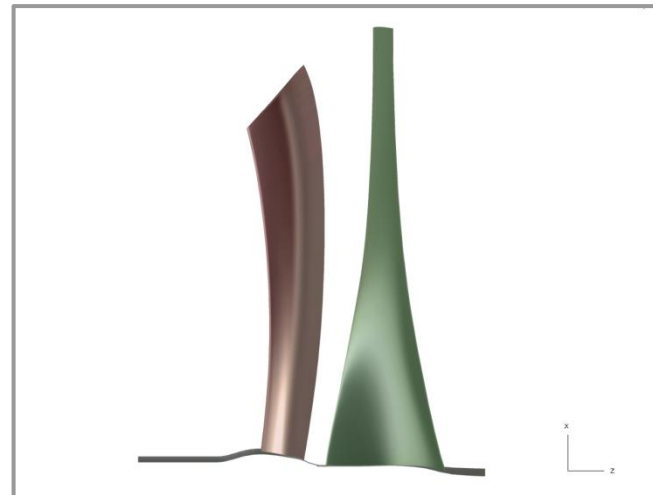
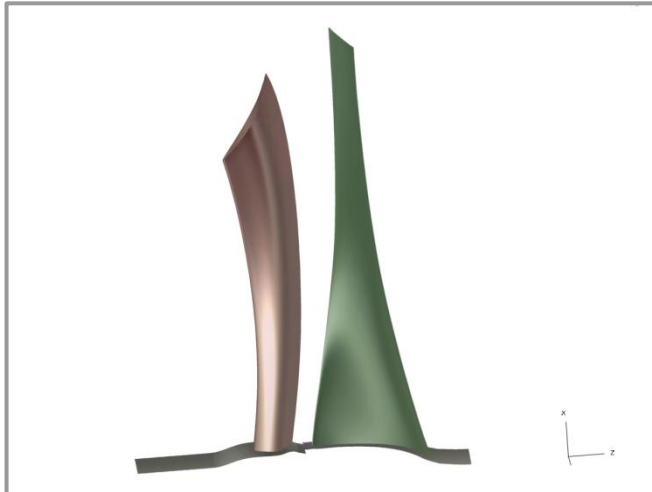

Best sample OPT 3

4

Results: Optimisation Blade Geometry

Copyright
NUMECA
42

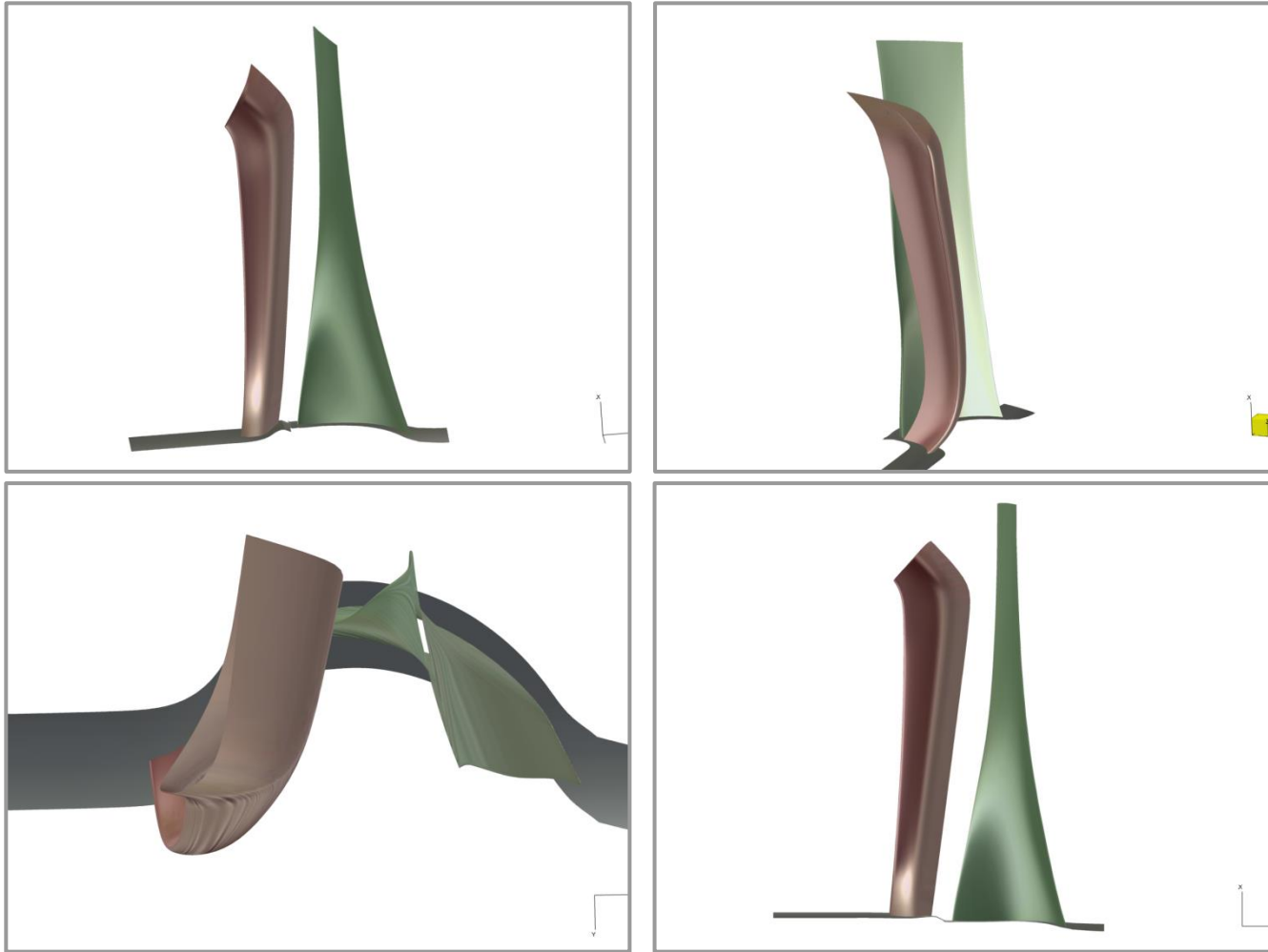

Best sample OPT 4



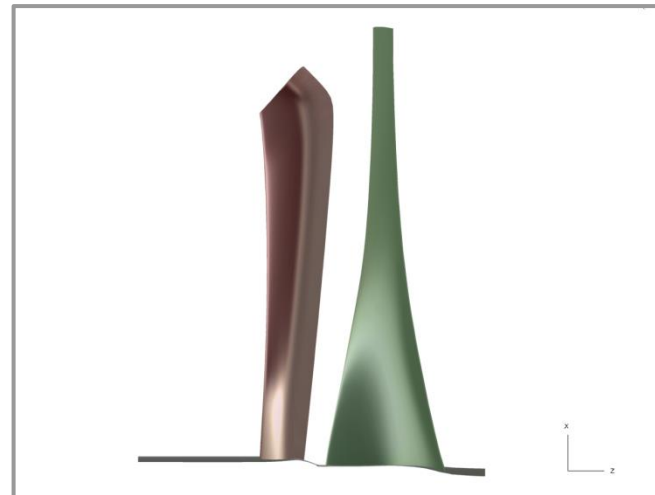
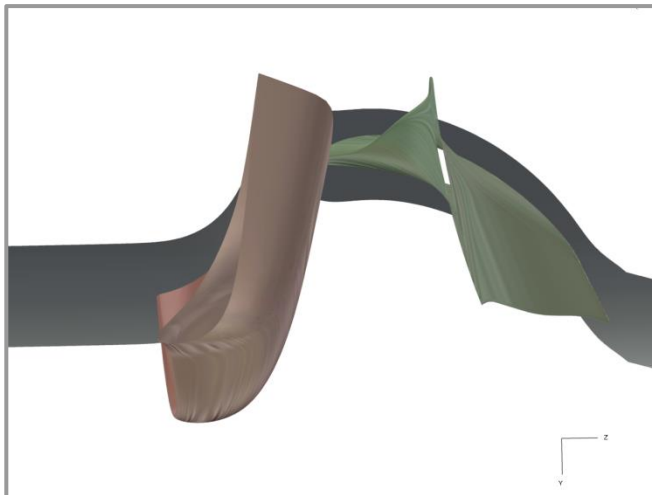
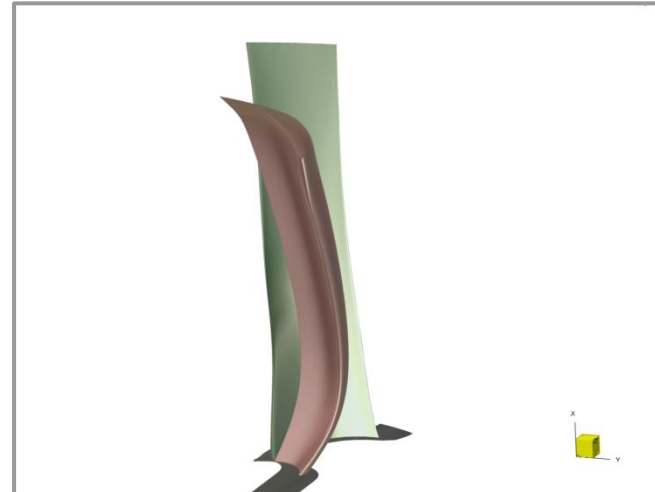
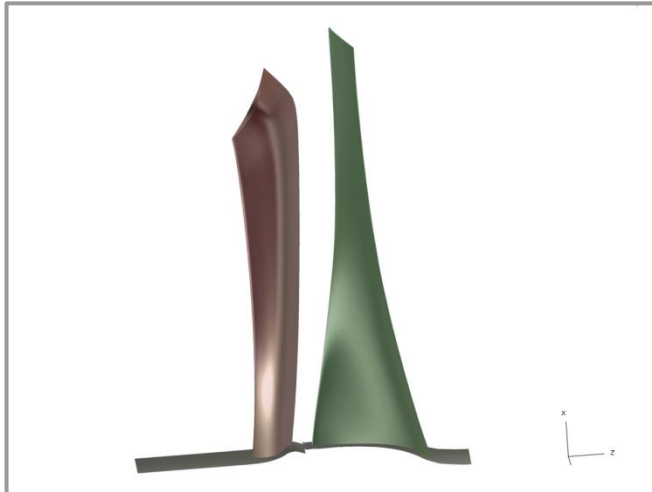

Best sample OPT 5

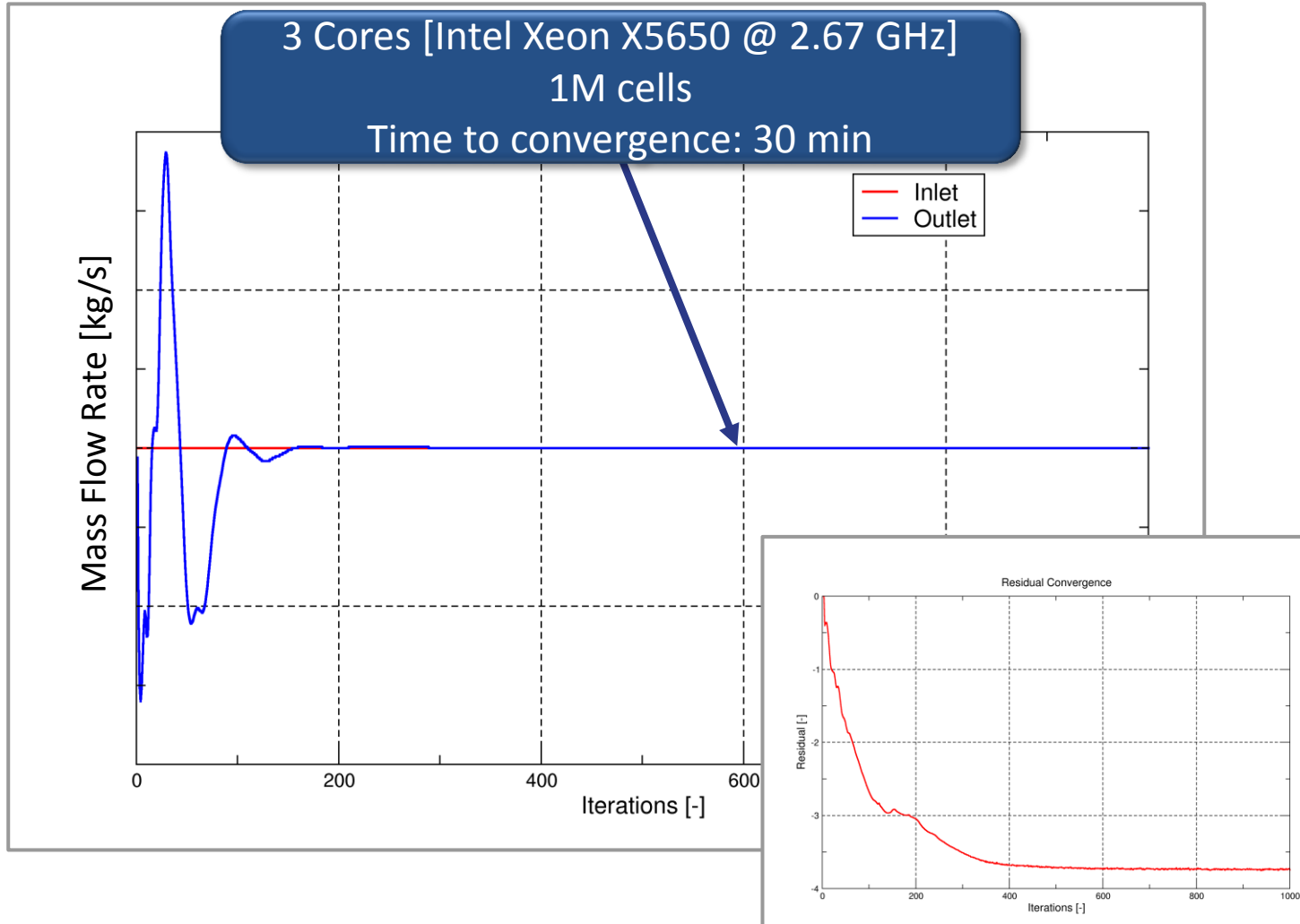

Total : ~ 700 designs [700 meshes, 2800 CFD runs, 700 post-processing runs]

Database already contained more efficient designs

Up to 2.5% increase in global efficiency is observed during optimisation

Whole characteristic shifted towards higher efficiency

Objective function definition very important

2014

End of Presentation

Thank you for your attention!

